

RADIO

SEPTEMBER, 1945

Design • Production • Operation

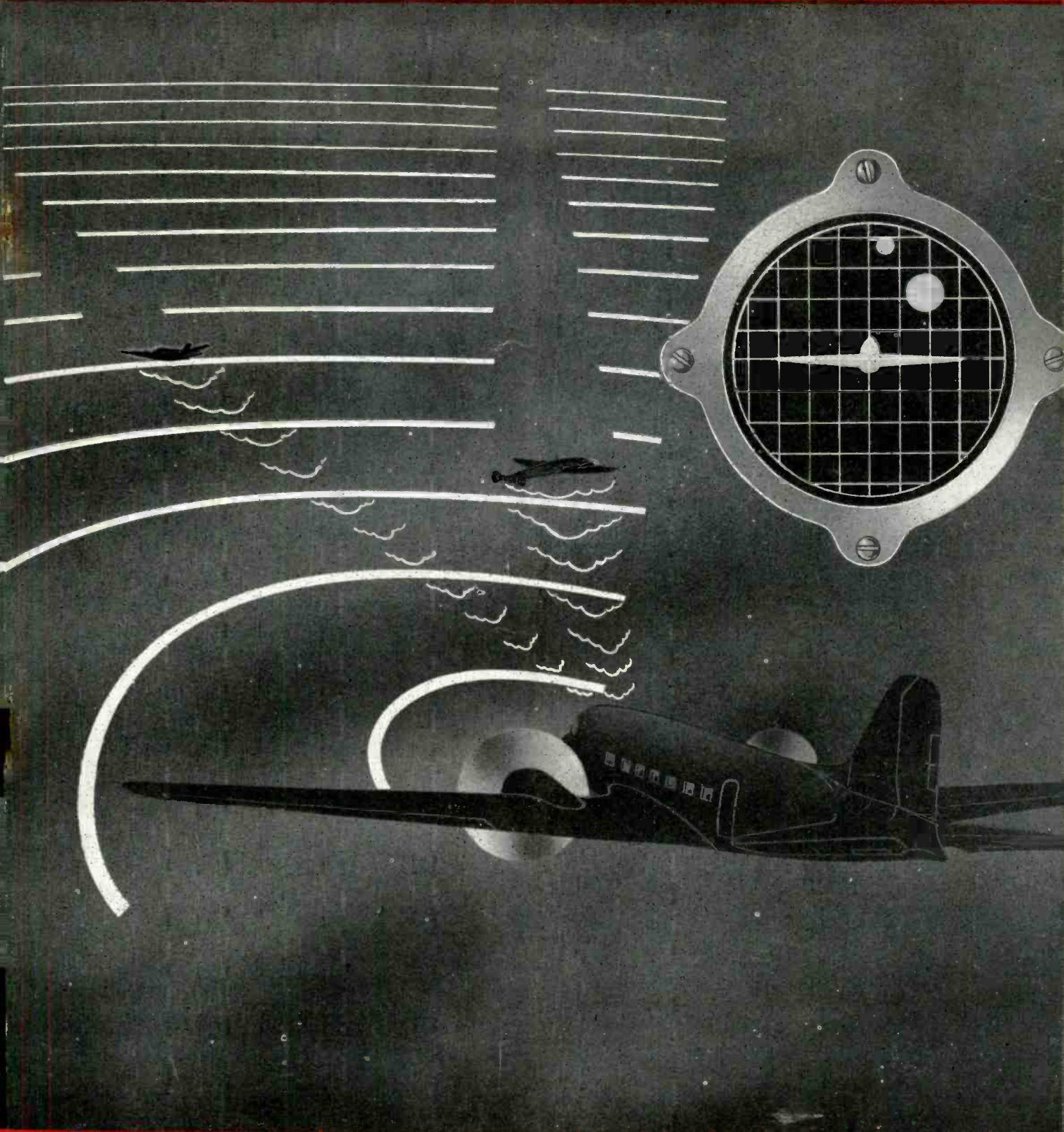

The Journal for Radio & Electronic Engineers

JUST ONE

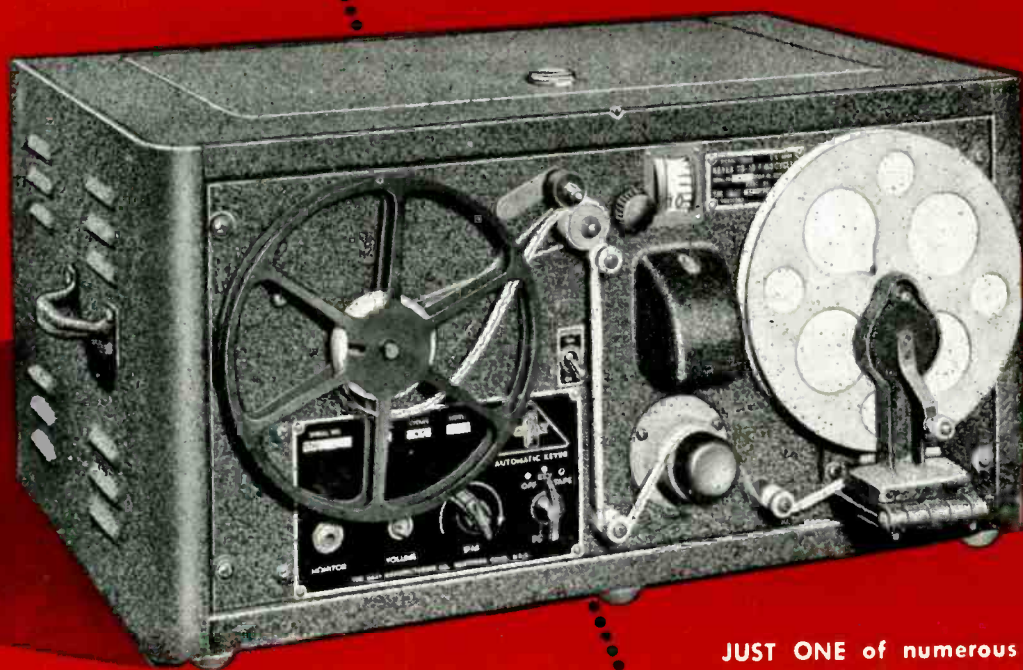

JUST ONE of numerous government radio and electronic items now available through the Hallicrafters Co., Chicago, agent for Reconstruction Finance Corporation.

This is a Keyer TG-10-F, an automatic unit for providing code practice signals from inked tape recordings. Excellent for group instruction, sufficient power to operate up to 300 pairs of head phones. Can be adapted as amplifier of 10 to 15 watts output for use with crystal mike or phono pick up. Completely checked and reconditioned by Hallicrafters engineers. Send coupon for further details and lists of other available items.

THESE VALUABLE ITEMS *Available Now*
or very soon. Write, wire or phone for further information

- head phones • test equipment • component parts • marine transmitters and receivers • code practice equipment • sound detecting equipment • vehicular operation police and command sets • radio beacons and airborne landing equipment

hallicrafters RADIO

HALLICRAFTERS CO., AGENT OF RFC UNDER CONTRACT SIA-3-24

WORLD'S LARGEST EXCLUSIVE MANUFACTURERS OF
SHORT WAVE RADIO COMMUNICATIONS EQUIPMENT

CLIP THIS COUPON NOW

RFC DEPARTMENT 110, HALLICRAFTERS
5025 West 65th Street • Chicago 38, Illinois

- Send further details and price on Keyer TG-10-F
 Send listings of other available items

Especially interested in.....

NAME.....

ADDRESS.....

CITY.....ZCNE.....

STATE.....

New! L-A-R-G-E-R Size Sheets of



Make Possible Many
Additional Uses for this
Superior Insulation

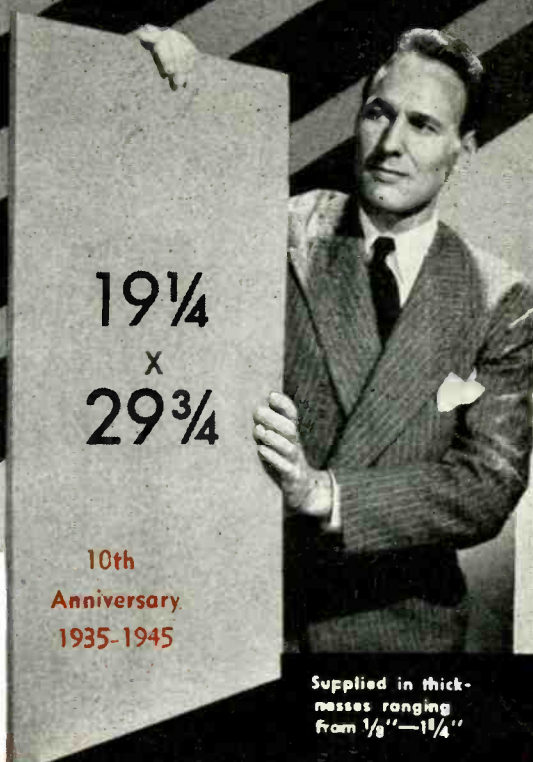

19 1/4
x
29 3/4

10th
Anniversary
1935-1945

Supplied in thick-
nesses ranging
from 1/8" — 1 1/4"

Now You Can Use MYKROY For:

- Large Terminal Boards
- Switch Board Panels
- Large Inductance Bars and Strain Insulators up to 29 inches long
- Switch Connecting Rods
- Transformer Covers
- Large Meter Panels
- Bases for Radio Frequency and Electrical Equipment assemblies requiring large one-piece sheets

HERETOFORE the largest sheet of glass-bonded mica insulation available measured 14 1/2" x 19 1/4". By doubling the size, Electronic Mechanics, exclusive manufacturers of Mykroy, now afford Design and Production Engineers many important, new application and fabricating advantages.

Lower Cost per square inch affects savings as high as 33% depending upon work piece size, greatly reducing the cost per fabricated part. Better Cutting efficiency lowers cost still further extending the use of Mykroy to a longer list of electronic applications where formerly cost prohibited its use.

Get the full facts about this versatile dielectric now. Ask for a copy of the new MYKROY BULLETIN 102 which describes the new, larger 19 1/4" x 29 3/4" sheets.

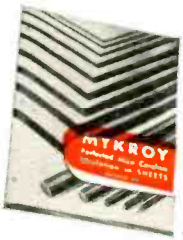

MECHANICAL PROPERTIES*

MODULUS OF RUPTURE.....	18000-21000psi
HARDNESS	Mohs Scale 3-4 BHN. BHN SCO K9 Load. 53-74
IMPACT STRENGTH.....	ASTM Charpy .34-.41 ft. lbs.
COMPRESSION STRENGTH.....	42000 psi
SPECIFIC GRAVITY.....	2.75-3.8
THERMAL EXPANSION.....	.000066 per Degree Fahr.
APPEARANCE.....	Brownish Grey to Light Tan

ELECTRICAL PROPERTIES*

DIELECTRIC CONSTANT.....	6.5-7
DIELECTRIC STRENGTH (1/2").....	630 Volts per Mil
POWER FACTOR.....	.001-.002 Meets AWS L-41

*THESE VALUES COVER THE VARIOUS GRADES OF MYKROY

- GRADE 8 Best for low loss requirements.
- GRADE 38. Best for low loss combined with high mechanical strength.
- GRADE 51 Best for molding applications.

Special formulas compounded for special requirements.

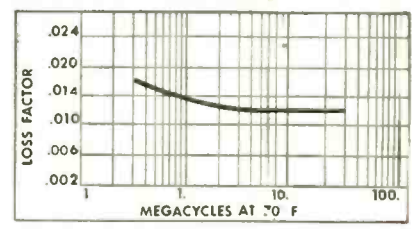

Based on Power Factor Measurements made by Boonton Radio Corp. on standard Mykroy stock.

MADE EXCLUSIVELY BY



70 CLIFTON BLVD., CLIFTON, N. J.
CHICAGO 47; 1917 N. Springfield Ave., Tel. Albany 4310
EXPORT OFFICE: 89 Broad Street, New York 4, New York

MYKROY IS SUPPLIED IN SHEETS AND RODS — MACHINED OR MOLDED TO SPECIFICATIONS

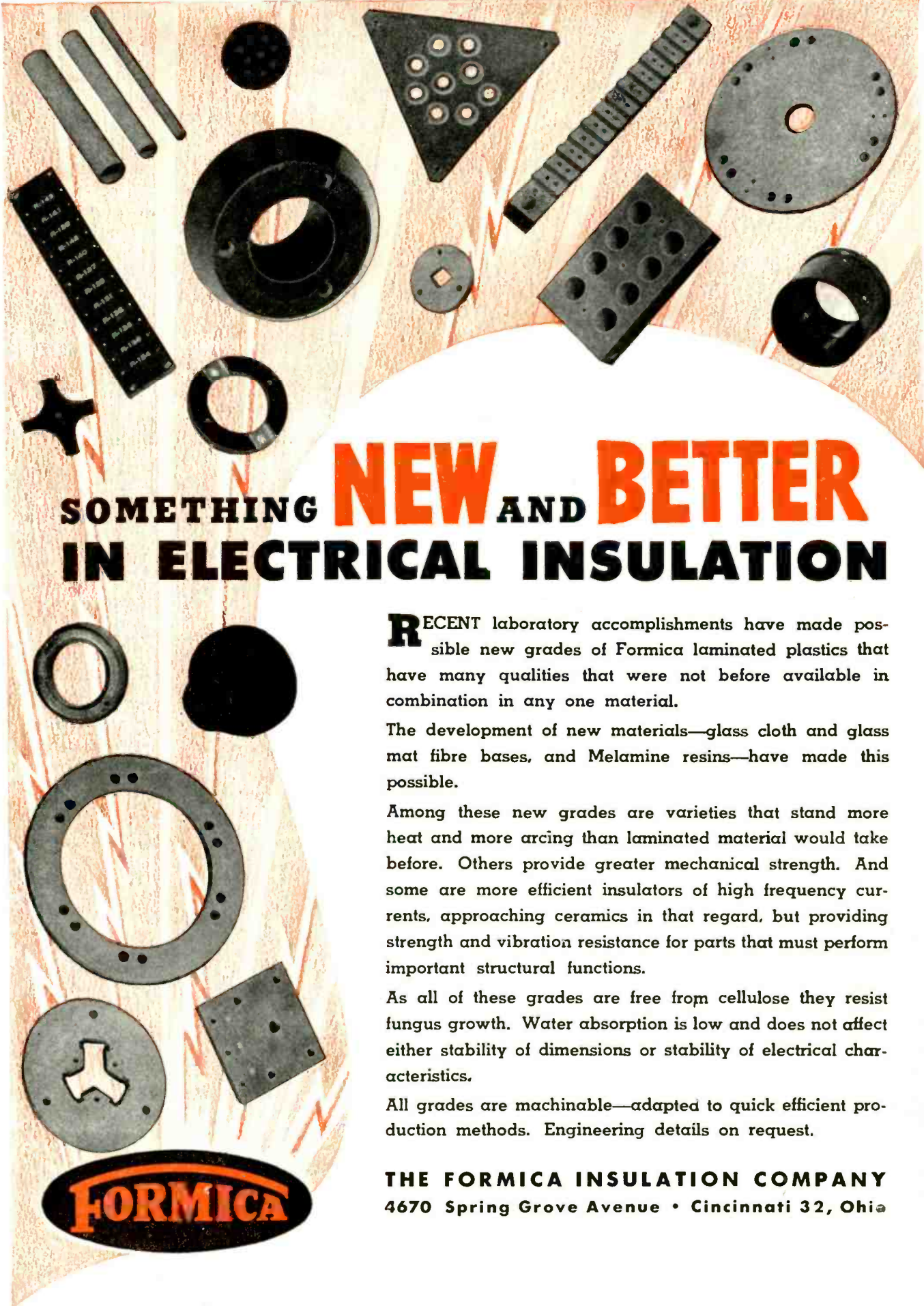

SOMETHING **NEW** AND **BETTER** IN ELECTRICAL INSULATION

RECENT laboratory accomplishments have made possible new grades of Formica laminated plastics that have many qualities that were not before available in combination in any one material.

The development of new materials—glass cloth and glass mat fibre bases, and Melamine resins—have made this possible.

Among these new grades are varieties that stand more heat and more arcing than laminated material would take before. Others provide greater mechanical strength. And some are more efficient insulators of high frequency currents, approaching ceramics in that regard, but providing strength and vibration resistance for parts that must perform important structural functions.

As all of these grades are free from cellulose they resist fungus growth. Water absorption is low and does not affect either stability of dimensions or stability of electrical characteristics.

All grades are machinable—adapted to quick efficient production methods. Engineering details on request.

THE FORMICA INSULATION COMPANY
4670 Spring Grove Avenue • Cincinnati 32, Ohio



RADIO

Published by RADIO MAGAZINES, INC.

John H. Potts Editor
Sanford R. Cowan Publisher

SEPTEMBER 1945

Vol. 29, No. 9

CONTENTS

COVER

One of the first adaptations of radar to commercial use will probably be the Proximity Indicator, an artist's conception of which is shown. Installed in a plane, this device will search an area in front of plane and indicate relative position of other planes or objects by dots of light on a screen. The grid on the screen enables the operator to judge distances (the closer the object, the larger the dot). A Proximity Indicator is one of the projects of the Technical Development Service of the CAA at its Indianapolis Experimental Station.

—CAA Aviation Information (Visual Services) C. R. McComas—artist

ARTICLES

Design Considerations in Small Receivers, A. C. Matthews	35
Effect of Dielectric Materials on Inductor Performance, A. C. Thompson	41
Modern Quartz Crystal Production, Part 2, Richard E. Nebel	44
Recent Trends in Precision Resistor Design, A. P. Howard	49
Frequency Conversion in Superheterodynes, M. A. Charles	53
Recent Radio Inventions—Device for Measuring Peak Currents; Coupling Device; Radio Altimeter and Panoramic Reception System; D-C Voltage Amplifier; Phase Angle Indicator; Homing Autopilot for Aircraft; Stabilized Oscillator; Frequency Modulation Detector	57
Radio Design Worksheet, No. 40: Inductive Balance Anti-Noise Circuit	61
Chart-Increase in Loss of Resistance Pad of 500-ohm Iterative Impedance Due to Termination Mismatch	62

MISCELLANEOUS

Transients	4
TECHNICANA	18
Circuit Diagrams	18
Counting Device	20
High-Speed Transmission	22
See-Saw Circuit	24
Piezo-Electric Crystals	26
Induction and Dielectric Heating Data	29
High-Frequency Heating	30
This Month	64
New Products	66
Advertising Index	83

John H. Potts President
Sanford R. Cowan Sec'y-Treas.
Charles H. Farrell Adv. Manager
Elaine Wilson Adv. Production
Miriam Birnbaum Circl. Manager

PACIFIC COAST REPRESENTATIVE

H. W. Dickow
1387 40th Ave., San Francisco 22, Calif.

GREAT BRITAIN REPRESENTATIVE

Radio Society of Great Britain,
New Ruskin House, Little Russell St.,
London, W.C. 1, England

RADIO Magazine (title registered U. S. Pat. Off.) is published monthly at Boston Post Road, Orange, Connecticut, by Radio Magazines, Inc. Executive and Editorial Offices at 342 Madison Avenue, New York 17, N. Y. Subscription rates—United States and Possessions, \$3.00 for 1 year, \$5.00 for 2 years; elsewhere \$4.00 per year. Single copies 35c. Printed in U.S.A. All rights reserved, entire contents Copyright 1945 by Radio Magazines, Inc. Entered as Second Class Matter October 31, 1942, at the Post Office at East Stroudsburg, Pa., under the Act of March 3, 1879. Permit for Second Class entry pending at Orange, Connecticut.

Transients

DISSENSION IN THE FCC

★ On August 24th, 1945, the Federal Communications Commission issued a summary of the rules it is now formulating for FM broadcasting. In Area I, the Northeastern section of the country, the Commission will increase the number of channels originally allocated to FM from 70 to 80. This will be done by taking over the two megacycles from 106 to 108 mc originally reserved for facsimile. These two megacycles will continue to be available for facsimile in the rest of the country and, in addition, facsimile will also have 10 mc between 470 and 480 mc.

There is no controversy in the FCC over this action, but two rules adopted at the same time have brought forth strong dissents from Commissioner Durr. These are that program duplication of AM transmissions is to be permitted on FM bands without restriction and that the Commission does not propose to reserve from assignment any FM channels at the present time.

Regarding program duplication, Commissioner Durr points out that this is an abandonment of the FCC established policy since 1940, whereby at least two hours of independent programming is required of every FM station operated by an AM licensee, and he fears that many licensees will be inclined to regard their FM licenses primarily as insurance policies protecting their AM operations against the risks of technological development, with the result that, for several years at least, the listening public will receive little more than the same program traffic carried over improved highways. FM, he states, will develop at the speed of the increase of listening sets in the hands of the public and, he believes, listeners will not be encouraged to buy FM receivers if their investment means only that they can hear a little more clearly the same programs which they now receive.

Insofar as Commissioner Durr's stand is concerned, we are in complete agreement. In fact, we believe that he has somewhat understated the case. A large proportion of the listening public in good metropolitan locations may find that they can detect little difference between FM and AM reception when switching from one band to another, and may conclude that all the claims for superior reproduction for FM are just talk. It is a matter of common experience that untrained ears are not appreciative of an extended frequency range, and where the location is such that there is no noise on AM reception, another advantage of FM will not be apparent.

We believe that this action by the FCC not only deprives the public of a wider range of program selection, but also constitutes a threat to radio manufacturers contemplating making combination AM-FM receivers.

Alternatively, the broadcasters should be required to add such features to program duplication as an increased dynamic range on FM broadcasts, so that the advantages of FM should be more readily apparent. It should be remembered that true fidelity comprises not only an extended frequency range, but also the same amount of contrast between fortissimo and pianissimo passages as is present in "live" orchestral performances. The latter is sadly missing in AM broadcasting, but there is no good reason why it should not be supplied for FM listeners. And it will be appreciated.

Commissioner Durr also feels that it is a mistake not to reserve for newcomers a band of twenty channels on the ground that there are many now in the armed services who would like to apply for FM broadcasting licenses and that, upon their discharge from the service, they are likely to find that in their communities the best channels, if not all, have already been allocated. With this viewpoint, we cannot go along. Setting up and financing such an enterprise is not a one-man proposition, and there is no reason why anyone now in the service cannot engage others of civilian status to handle this work for him. Reserving channels for an indefinite period means that it would take that much longer to render FM service to such communities, and would lessen the demand for receivers.

OPA PRICING OF RADIO COMPONENTS

★ Preliminary increase factors for tubes and parts for original equipment as established by the OPA allow radio components manufacturers increases ranging from 5 to 11 per cent over the ceiling price for the October 1-15, 1941 period. This has caused an understandable revolt among radio parts manufacturers, most of whom operated on very close profit margins before the war and whose costs have since risen tremendously. Largest increases have been allowed for tubes, because, the OPA states, more complete financial data was supplied by such manufacturers.

Every parts manufacturer should see to it that similar complete data is immediately presented to the OPA to justify a greater increase for his products. This should not be hard to supply, what with the enormous increase in labor costs which constitute the main item of production cost. It would be extremely unfortunate if the delay in proper adjustment of these increase factors should hold up receiver production at a time when the demand is the greatest in radio history. Further, it may result in an influx of imported receivers, already appearing in small quantities, of sufficient magnitude to upset the demand for our advertised brands and thus unsettle the consumer demand and delay reconversion.

—J. H. P.

Specialized Knowledge and Equipment for **UHF DESIGN**

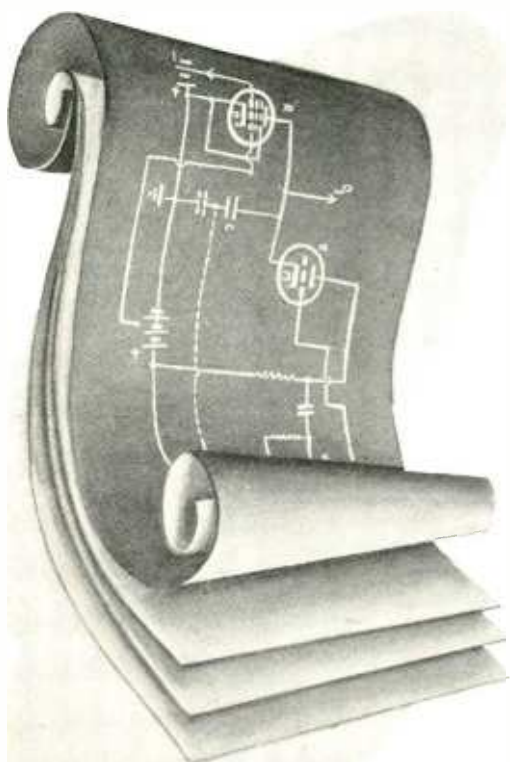

● The phenomena encountered in the UHF field are in many cases so decidedly different from those true of lower frequencies that many manufacturers find themselves in urgent need of specialized UHF knowledge, in order to develop equipment that will handle certain specific conditions.

● Since we are specialists in UHF engineering, we are equipped not only to render technical advice, but also to follow through in the actual production of equipment in our shops.

● Of necessity, during the war period, our efforts have been concentrated largely on Army and Navy work. Now that peace is with us, we have adequate time to devote to civilian requirements. We invite discussion of any problems you may have in the UHF field.



Lavoie Laboratories

RADIO ENGINEERS AND MANUFACTURERS
MORGANVILLE, N. J.

**Specialists in The Development of UHF Equipment
and in The Manufacture of UHF Antennas**



The Famous Three!

Tinker, Evers and Chance were famous for Stamina, Efficiency and Fine Performance. So are all RACON Products!

There's a RACON speaker, horn and driving unit for every conceivable sound distribution application. Only RACON can supply, when needed, another famous three-in-one combination — Weatherproof, Stormproof, Acoustic Material which is impervious to any weather condition and prevents resonant effects.

Now that industrial war plants can obtain sound installations, remember that RACON's should be used to afford peak efficiency.

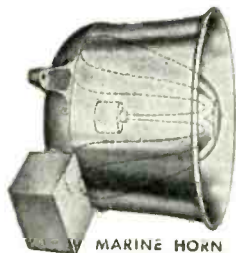

MARINE HORN



RE-ENTRANT TRUMPETS



P.M. UNITS

MARINE HORN SPEAKERS, approved by the U. S. Coast Guard, may be used as both speaker and microphone. Available in several sizes.

RE-ENTRANT TRUMPETS, compact, of the double re-entrant type, afford long air-column in small space; deliver highly concentrated sound over long distances.

P.M. HORN UNITS are available in operating capacities of 5 to 50 watts.

RACON ELECTRIC CO. 52 E. 19th ST., N. Y.

RACON



Presenting

No. 150,003,414!

With a war record of more than one hundred and fifty million successful "missions" to their credit, IRC's

BTS INSULATED METALLIZED RESISTORS

have given unquestioned evidence of their complete dependability.

The exact counterparts of these efficient and precision-engineered "veterans" are now available in quantities for your own essential requirements.

Their construction features, resistance-temperature characteristics and specifications are described fully and charted graphically in Bulletin #3 which will be sent to you upon request directed to Dept. 7-1.



INTERNATIONAL RESISTANCE CO.

401 N. BROAD STREET • PHILADELPHIA 8, PA.



IRC makes more types of resistance units, in more shapes, for more applications than any other manufacturer in the world.



THE BIRD WITH THE 16-MILE TAIL

The wire you see with the parachute on the end of it is a telephone wire, being payed out from a C-47 cargo plane.

Bell Telephone Laboratories, working with the Air Technical Service Command of the Army Air Forces, developed this idea. It will save precious lives and time on the battlefield.

A soldier throws out a parachute with the wire and a weight attached. The weight drops the line to the target area. From then on, through a tube

thrust out the doorway of the plane, the wire thrums out steadily — sixteen miles of it can be laid in $6\frac{2}{3}$ minutes. Isolated patrols can be linked quickly with headquarters. Jungles and mountain ranges no longer need be obstacles to communication.

This is in sharp contrast to the old, dangerous way. The laying of wire through swamps and over mountains often meant the transporting of coils on the backs of men crawling through

jungle vegetation, and in the line of sniper fire. It is reported that in one sector of the Asiatic theater alone, 41 men were killed or wounded in a single wire-laying mission.

Bell Telephone Laboratories is handling more than 1200 development projects for the Army and the Navy. When the war is over, the Laboratories goes back to its regular job — helping the Bell System bring you the finest telephone service in the world.



BELL TELEPHONE LABORATORIES

Exploring and inventing, devising and perfecting for the Armed Forces at war and for continued improvements and economies in telephone service.



IN A SKY FILLED WITH WORDS AND PICTURES

AMPHENOL

Aids Clear, Strong Reception

Present and future demands for clearer reception challenge the skill of the world's best radio and television engineers. Amphenol electronic scientists have met that challenge emphatically. The Amphenol name is internationally symbolic of quality—quality in not one, not a few, but in scores of available component parts such as Adapters, Coaxial Cable, Coil Forms, Connectors, Insulators and Material, Plugs, Sockets, Hardware and Accessories.

AMERICAN PHENOLIC CORPORATION
Chicago 50, Illinois
In Canada • Amphenol Limited • Toronto

U. H. F. Cables and Connectors • Connectors (A-N, British) • Conduit • Cable Assemblies
Radio Parts • Plastics for Industry



SYLVANIA NEWS

ELECTRONIC EQUIPMENT EDITION

SEPT.

Published by SYLVANIA ELECTRIC PRODUCTS INC., Emporium, Pa.

1945

UNIVERSAL TEST UNIT CHECKS RADIO TUBES —ELECTRONIC DEVICES

Another essential electronic apparatus manufactured by the Industrial Apparatus Division of Sylvania Electric at Williamsport, Pa., is shown in accompanying photographs.



Above is the front view of the Universal Test Unit that preheats all tubes except rectifier, short tests all tubes (each element separately), noise tests RF and AF tests, static tests all tubes for all characteristics except plate resistance and amplification factor, dynamic tests mutual conductance, gain and power output at 400 cycles.

In addition, it may be adapted to test many other types of electronic devices by simply changing a small socket adaptor, and can be equipped with automatic tappers for short and noise tests.

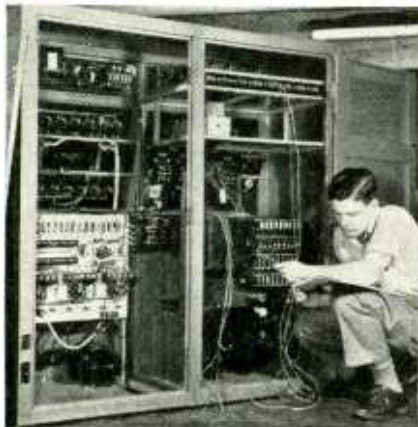

Rear view Universal Test Unit

HIGH FREQUENCY TUBE ALSO BEST FOR ALL RADIOS

*“Lock-In” Not Only Ideal For FM,
Television, But Better For Other Type Sets*

An outstanding advantage of Sylvania Electric's advanced type radio tube—the Lock-In—is its perfect suitability for *any* class radio set—portable battery, farm battery, household, automobile, marine or aircraft.

Not Limited In Use

Although the basic electrical and mechanical advantages of the Lock-In construction are right in step with the continuing trend of the industry toward higher frequencies, these exceptional qualities do not limit the tube's applicability.

Set Performance Improved

On the contrary, this superiority is reflected in the better performance attained in all sets employing Sylvania Lock-In Tubes.

Write today for further information. *Sylvania Electric Products Inc., Emporium, Pa.*



9 POINTS OF MERIT

- 1 Lock-In locating plug . . . also acts as shield between pins.
- 2 No soldered connections . . . all welded for greater durability.
- 3 Short, direct connections . . . fewer welded joints — less loss.
- 4 All-glass header . . . better spacing of lead wires.
- 5 No glass flare . . . unobstructed space for internal shielding.
- 6 Improved mount support . . . ruggedly mounted on all sides.
- 7 Getter located on top . . . shorts eliminated by separation of getter material from leads.
- 8 No top cap connection . . . overhead wires eliminated.
- 9 Reduced overall height . . . space saving.

REMEMBER THIS EMBLEM



IT STANDS FOR
HONORABLE
SERVICE TO
OUR COUNTRY

SYLVANIA ELECTRIC

Emporium, Pa.

MAKERS OF RADIO TUBES; CATHODE RAY TUBES; ELECTRONIC DEVICES; FLUORESCENT LAMPS, FIXTURES, WIRING DEVICES; ELECTRIC LIGHT BULBS

The Latch String Is Always Out

Why Not Pay Us a Visit

If you would permit us to pilot you through the various departments of our modern plant, you would readily understand why Jefferson Electric has earned the reputation for sustained quality in quantity production.

You would agree that it would be difficult to find a plant with all of the many features needed to produce in such quantities with such high standards of quality, accuracy and uniformity.

Engineering, research, experimental departments geared to the latest manufacturing methods and technique are combined with modern equipment and unusual esprit de corps.

When in Chicago, plan to pay us a visit, —our suburban location is readily accessible. For your convenience you can call us by local Chicago telephone—Mansfield 7161. JEFFERSON ELECTRIC COMPANY, Bellwood (Suburb of Chicago), Illinois. *In Canada:* Canadian Jefferson Electric Co., 384 Pape Avenue, Toronto, Ontario.

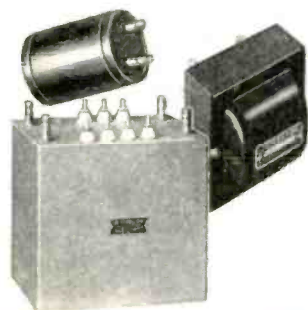

TRANSFORMERS

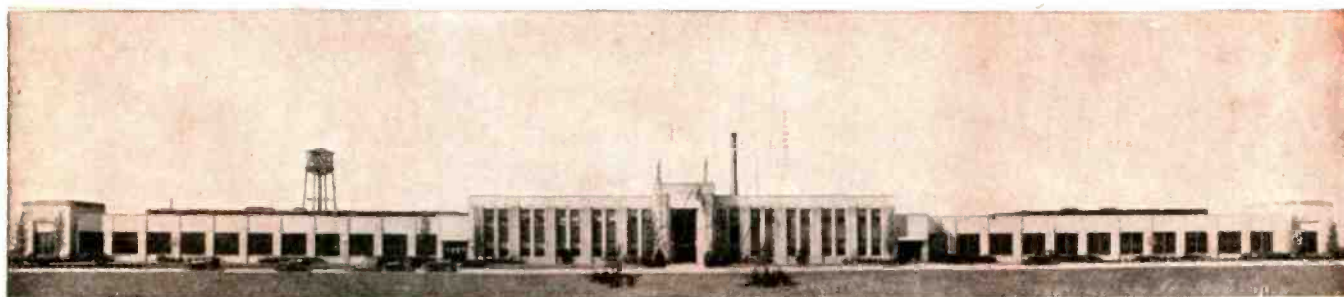

HERE'S PROOF...

How Federal H-F Cable
Quality is Controlled by

Actual Test

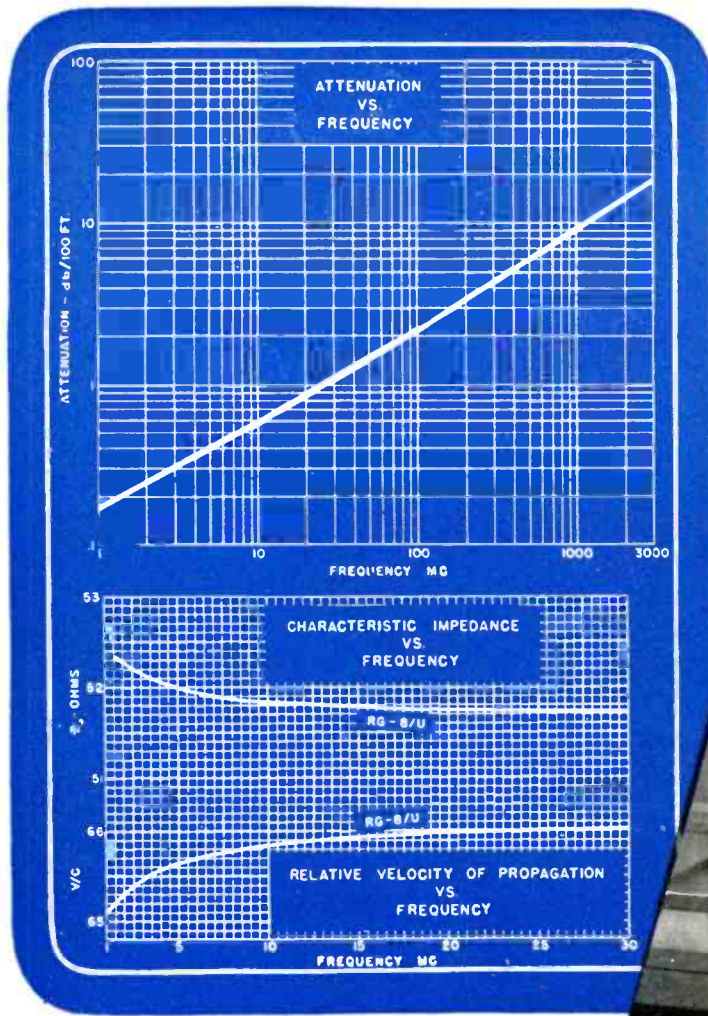

Precision engineering—plus careful control of all manufacturing operations . . . from raw materials to finished product—mean complete reproducibility in any given Intelin Cable type . . . and overall superior cables.

Take Intelin RG-8/U for instance . . . general purpose “work-horse” of high-frequency cables. Its characteristics are shown in curves obtained—not from nominal design values—but from thousands of actual measurements on cable samples, with special equipment developed and used exclusively by Federal’s Intelin Product Line.

Intelin’s Attenuation Meter is an example of such equipment. It’s a precision instrument . . . accurate to .1 db . . . developed by Intelin to provide a constant check on production quality and “measured” data for the equipment designer.

For additional information regarding Intelin RG-8/U . . . write *today* for Report E-53 —and for cable you can count on . . . *always* specify INTELIN.



Federal Telephone and Radio Corporation

Newark 1, N. J.



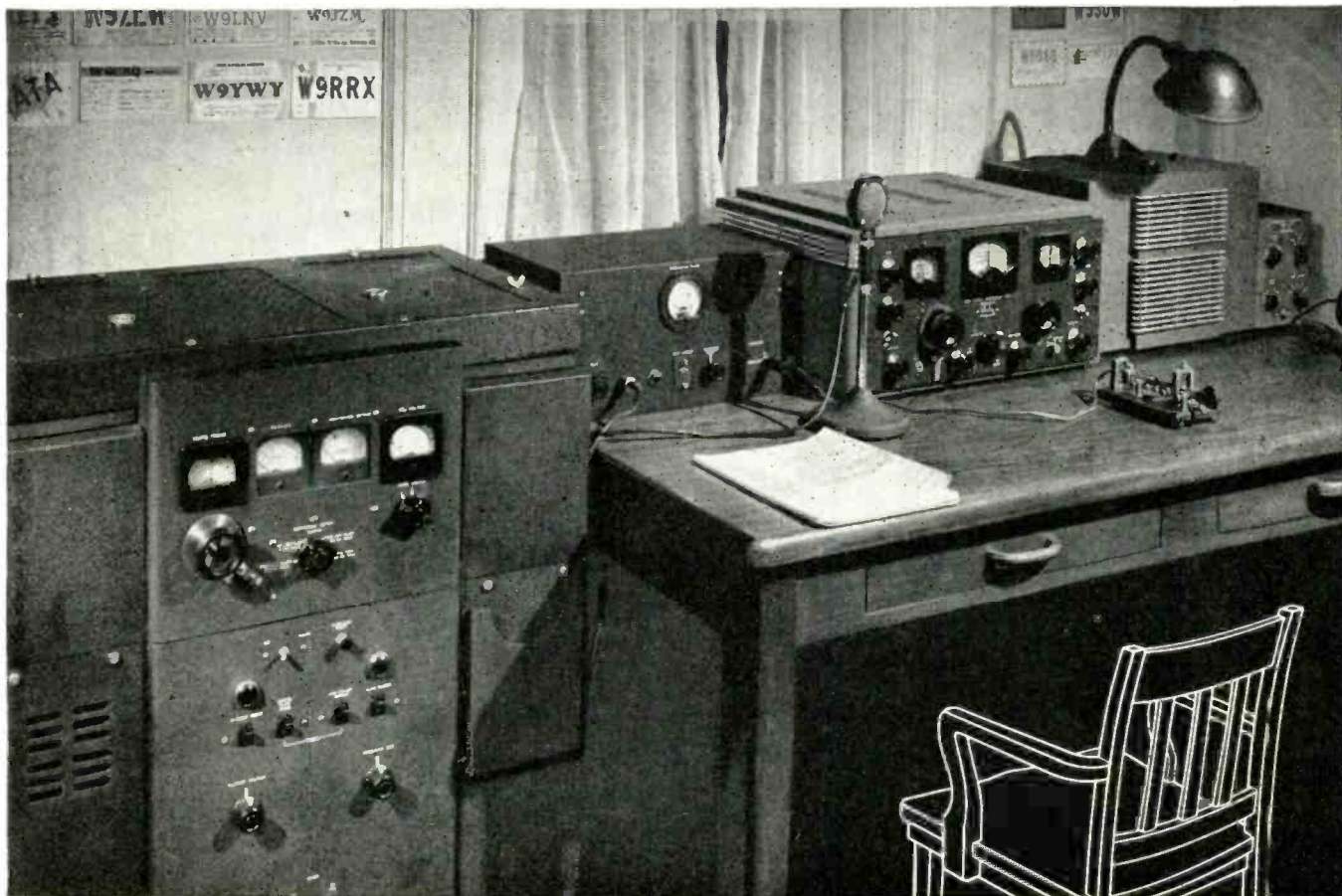

Pull up a chair!

Get a ringside seat at the ideal ham shack of tomorrow. The above picture was made at Hallicrafters Ham Shack on the Boulevard, in Chicago. But no picture can represent, no artist can paint what Hallicrafters has in store for the amateurs when the demands of war production are relaxed. Rugged, dependable, sensitive high frequency transmitters and receivers—like the HT-4 which went to war as the famous mobile radio station SCR-299 and the SX-28A, the great communications receiver—belong in the postwar picture of your ideal ham shack. Hallicrafters

equipment has been constantly refined and developed under the fire of war. In peace it will come closer than ever to meeting the exacting requirements of the radio amateur who has played such a prominent part in the progress of all radio and who assumed such a valuable role in war communications.

Even now you can "pull up a chair" in your ideal ham shack by sending for Hallicrafters 1945 Catalog . . . a fascinating piece of ham literature . . . detailed specifications on more than 20 models that are helping to win the radio war. Specify Catalog S-36A.

COPYRIGHT 1945 THE HALLICRAFTERS CO.

BUY A WAR BOND TODAY!



hallicrafters RADIO

THE HALLICRAFTERS CO., WORLD'S LARGEST EXCLUSIVE MANUFACTURERS OF SHORT WAVE RADIO COMMUNICATIONS EQUIPMENT, CHICAGO 16, U. S. A.

RADIO

★ SEPTEMBER, 1945

13



The *Quiet Ballentine* Changer Motor

has these four characteristics achieved by advanced design, skilled engineering and precision manufacturing

- Lowest Rumble
- Highest Efficiency
- Most Compact Design
- Longest Life

The *Quiet Ballentine* Changer Motor is recommended to record changer manufacturers seeking to provide the ultimate in performance.

RUSSELL ELECTRIC COMPANY

370 WEST HURON STREET • CHICAGO 10, ILLINOIS

Manufacturers of **BALLENTINE**
RECORD CHANGER MOTOR

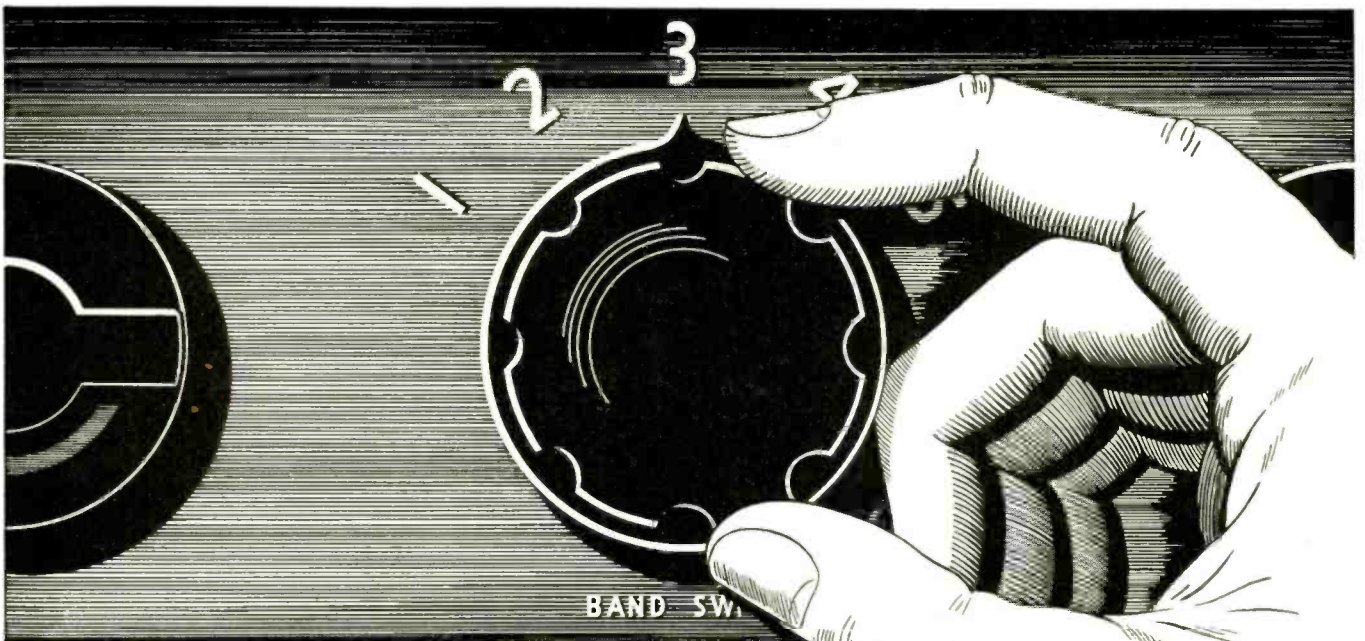

For easier bandswitching use the 257B Gammatron!

The HK-257B beam pentode, originated by Heintz and Kaufman engineers, facilitates the design, construction, and operation of multi-band transmitters since it requires very little driving power and no neutralization.

The wiring diagram below shows a transmitter capable of operating on all amateur bands from 10 to 160 meters. A single 6V6 metal tube in the oscillator circuit drives the r.f. amplifier to its full output. The precise internal shielding of the HK-257B makes neutralization unnecessary.

Write today for complete data on the 257B Gammatron, a versatile tube capable of very high frequency operation.

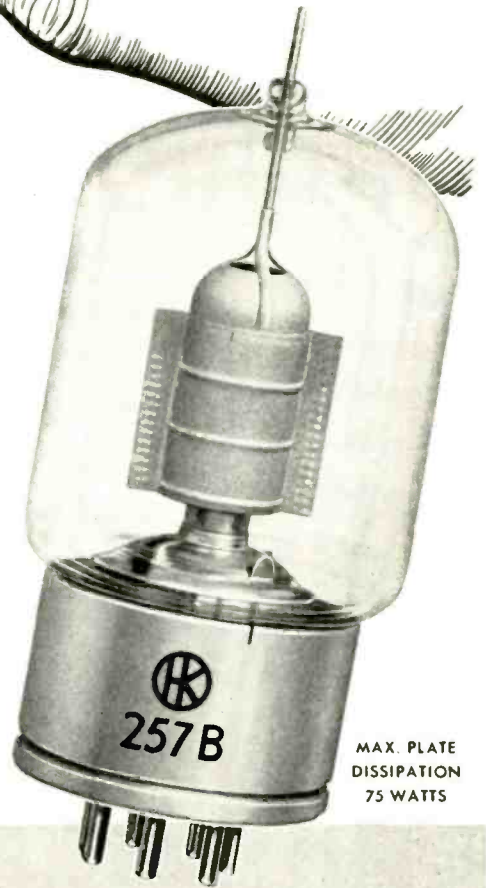

MAX. PLATE DISSIPATION
75 WATTS

HEINTZ AND KAUFMAN LTD.

SOUTH SAN FRANCISCO • CALIFORNIA



Export Agents: M. Simon and Son Co., Inc.
25 Warren Street • New York City

KEEP IT UP... BUY WAR BONDS

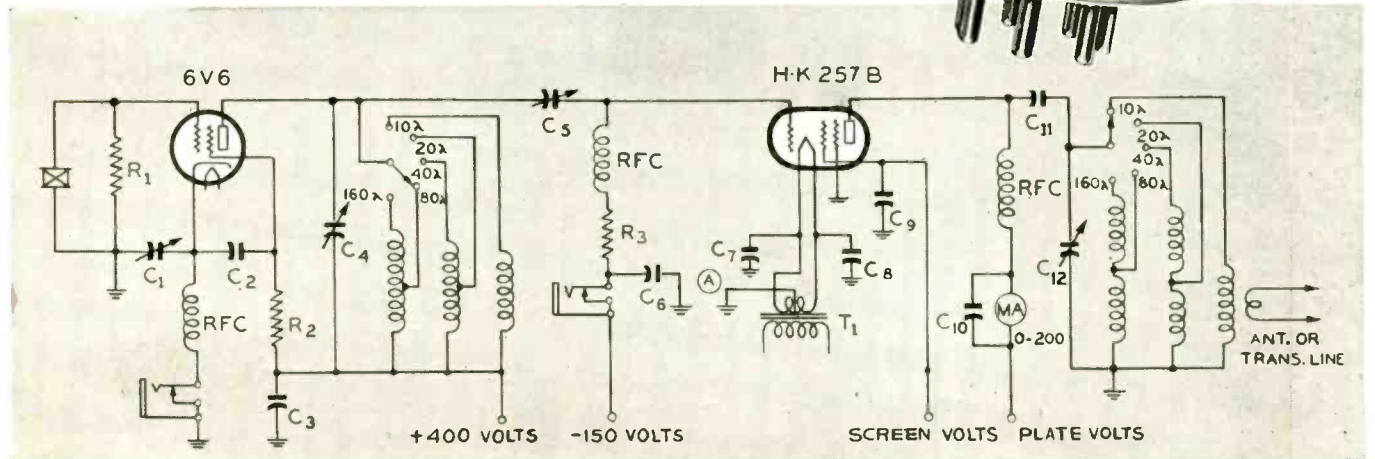

3 OUTSTANDING FEATURES OF THE NEW EIMAC 4-125A TETRODE

1 LOW DRIVING POWER

With but 2.5 watts driving power, the 4-125A will deliver 375 watts output at frequencies as high as 120 Mc. The low driving power requirement has been achieved without the use of excessive secondary emission. The control grid is specially processed to reduce both primary and secondary emission.

2 HIGH FREQUENCY PERFORMANCE

The Eimac 4-125A will deliver 200 watts output at 250 Mc. The performance curves below show the relationship between driving power and power output at frequencies up to 250 Mc.

FOLLOW THE LEADERS TO



EITEL-McCULLOUGH, Inc., 1085 San Mateo Avenue, San Bruno, Calif.

Plants located at: San Bruno, California and Salt Lake City, Utah

Export Agents: Fraxar & Hansen, 301 Clay St., San Francisco 11, Calif., U. S. A.

3 LOW GRID-PLATE CAPACITANCE

The grid-plate capacitance of the 4-125A is only 0.03 *uufd*. This low value allows operation up to 100 Mc. without neutralization. Stability is further assured by the special grid processing which reduces secondary emission.

A technical bulletin on Eimac 4-125A Power Tetrode contains full specifications and detailed discussion of the tube's characteristics, circuit diagrams and constant current curves. Write for your copy today.

The Eimac 4-125A is the first of many new Eimac tubes that are on the way. Watch for future announcements.

ELECTRICAL CHARACTERISTICS

Filament: Thoriated Tungsten

Voltage 5.0 volts

Current 6.2 amperes

Plate Dissipation (Maximum) 125 watts

Direct Interelectrode Capacitances (Average)

Grid-Plate (Without shielding, base grounded) 0.03 *uufd*.

Input 10.3 *uufd*.

Output 3.0 *uufd*.

Transconductance ($i_b = 50$ ma.,

$E_b = 2500$ v., $E_{c2} = 400$ v.) . 2450 *umhos*

1085

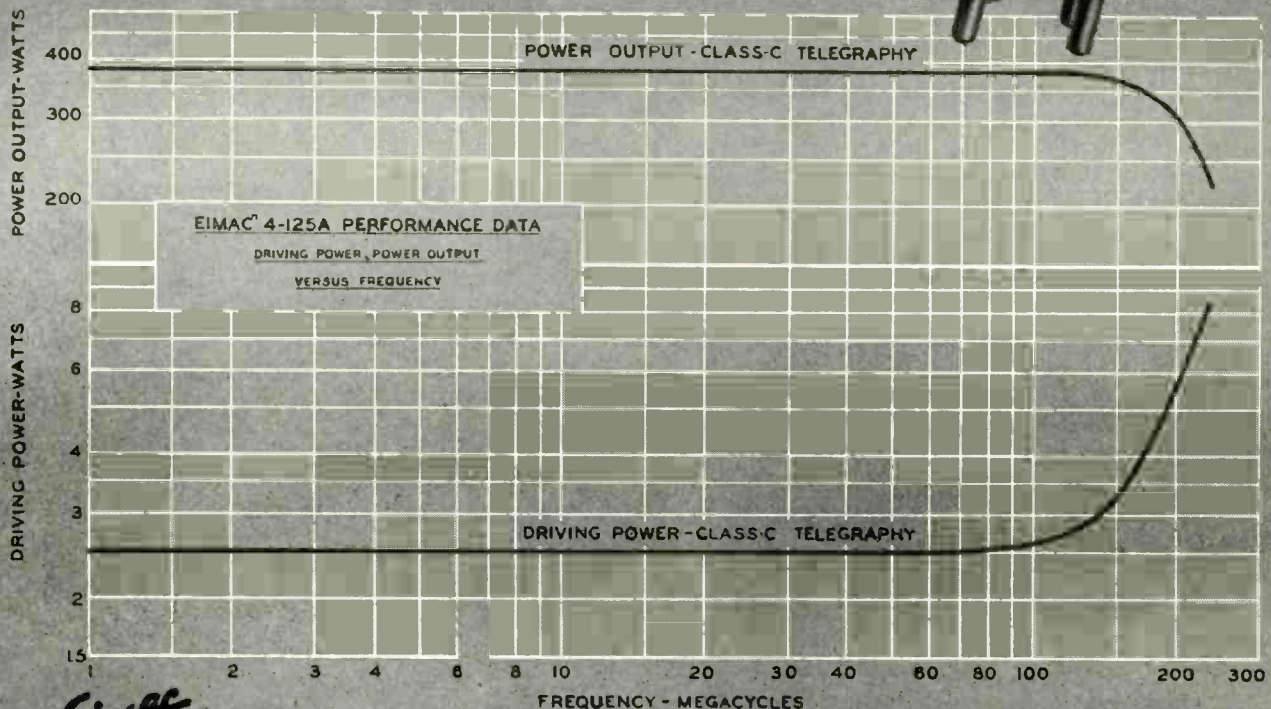

THE COUNTERSIGN OF DEPENDABILITY IN ANY ELECTRONIC EQUIPMENT

**Esquire
delivers
exceptional
results
for leading
radio
advertisers**

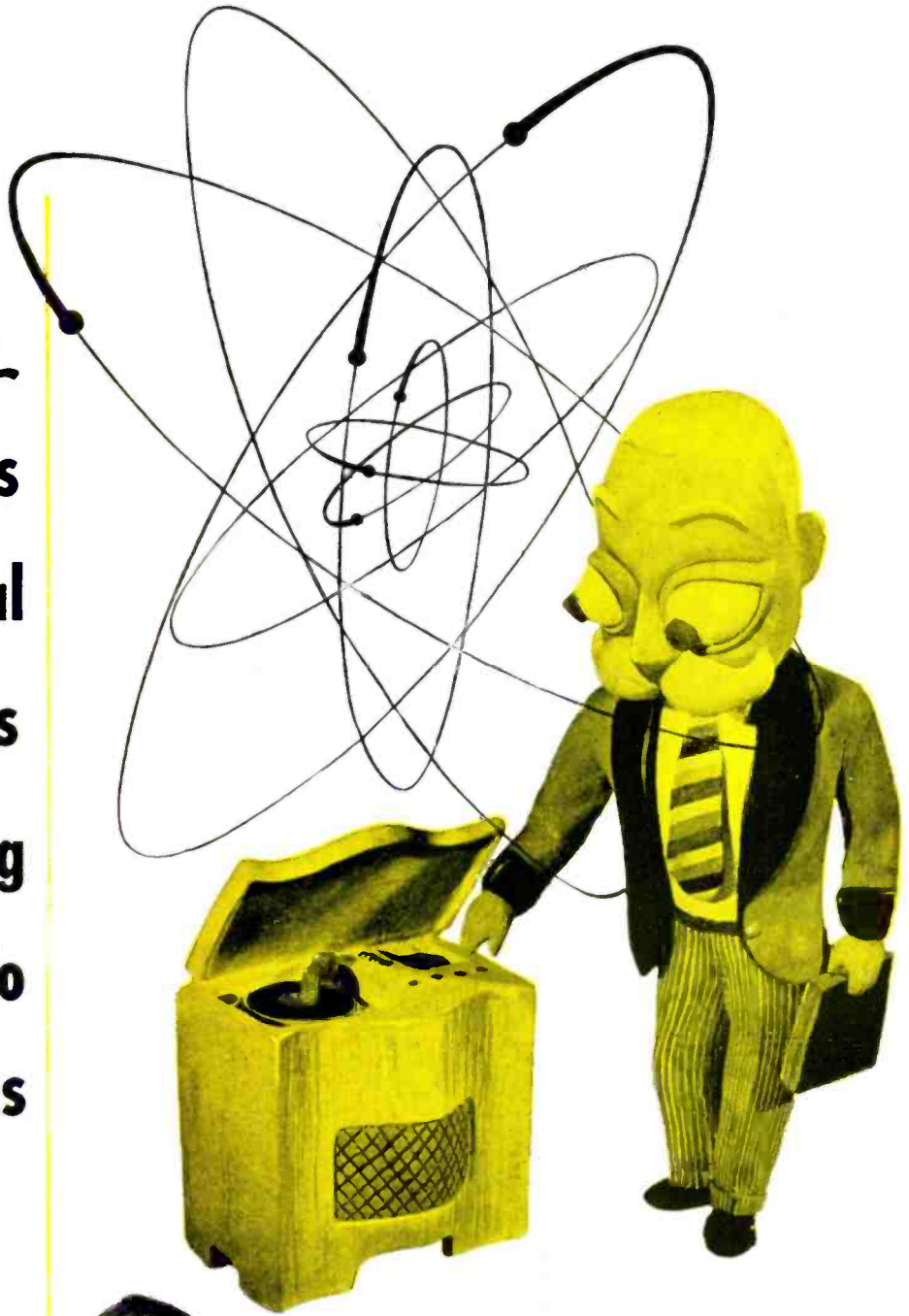

Esquire



puts a man ^{*} in the mood to buy

Esquire also delivers exceptional results for national advertisers of many other products in virtually every field.

** and millions of women, too*

40 DEGREE

Vertical



AREA OF DISTRIBUTION

The new amazing Altec Lansing multi-cellular Duplex Speaker provides up to 800% increased area of quality sound distribution. In the vertical plane, the Duplex delivers a forty degree angle of distribution, or eight times the area distribution at high frequencies as compared to single unit speakers of comparable size. Another reason why the DUPLEX is the SPEAKER that REVOLUTIONIZES the methods of sound REPRODUCTION.

SEND FOR BULLETINS

ALTEC

LANSING CORPORATION

1210 TAFT BLDG., HOLLYWOOD 28, CALIF.
250 WEST 57 STREET, NEW YORK 19, N. Y.
IN CANADA: NORTHERN ELECTRIC CO.

TECHNICANA

CIRCUIT DIAGRAMS

* A note of interest to those in this country who would standardize electronic circuit diagrams is found in an article by Mr. L. H. Bainbridge-Bell in the June 1945 *Electronic Engineering*.

Mr. Bell presents some rather sound rules to be followed by the circuit delineator, but at the same time suggests the elimination of certain right angle bends which would result in a circuit diagram somewhat new in appearance.

Mr. Bell's fundamental rules are briefly as follows:

1. Do not attempt to make a circuit diagram also serve as a wiring diagram.
2. If component location is important use a suitable note. Functional position, however, is essential.
3. The eye readily follows smooth curves around 90° bends; therefore eliminate sharp corners when possible, but do not use smooth curves which are not the paths from "cause" to "effect".
4. Do not permit two incidents to occur at the same point (e.g., a sudden change in direction of one wire at the point where it crosses another).
5. A man with his hands tied behind his back should be able to follow every lead (without use of his finger or pencil for guidance). To this end the equal spacing of more

connection, and follow the effect to determine correctness of direction.

It is acknowledged that in some cases a flow in two directions is possible, as for example in a multi-vibrator synchronized from the left but with high voltage at the right. Arrows may then point in opposite directions.

The author favors the use of bridged crossings (*Fig. 1a*) rather than straight

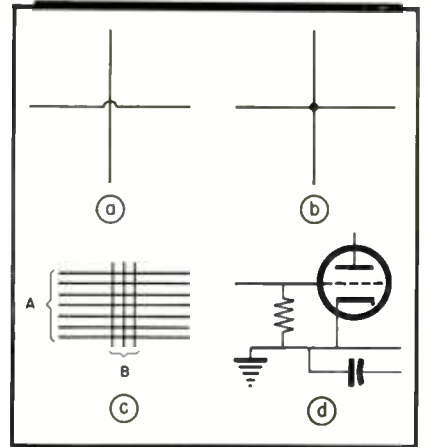

Figure 1

crossings and reports that a survey of publications shows that about 50% of the magazines use bridged crossings, and that in textbooks the ratio of bridges to straight crossings was as high as 4 to 1.

With the straight crossing (*Fig. 1b*) a dot is required to indicate a connection. With bridged crossings there can be no doubt.

An exception to the bridging convention would be permitted for a multiple

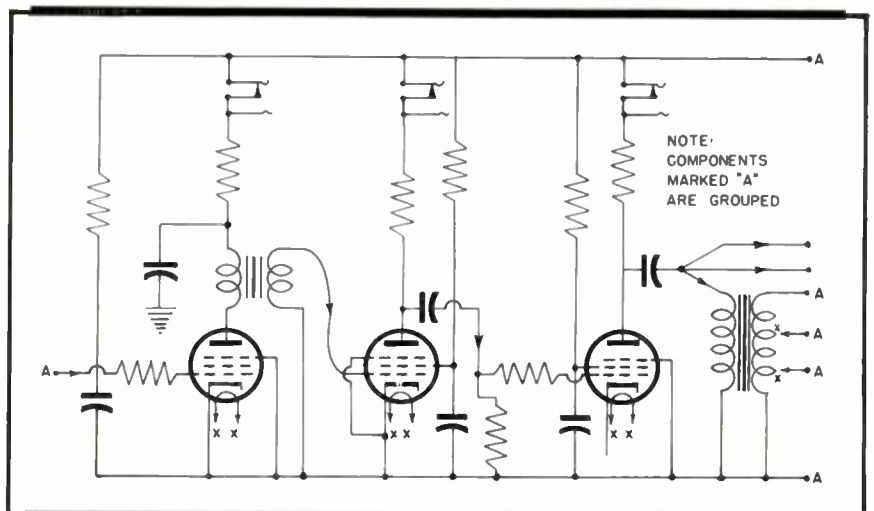

Figure 2

than four parallel wires should be avoided.

6. Coding marks such as $\rightarrow\rightarrow\rightarrow$ and $\rightarrow\rightarrow\rightarrow\rightarrow$ should be used when possible. The flow from "cause" to "effect" should be from left to right. When in doubt, break the

crossing, for which no possible confusion could occur, as shown in *Fig. 1c*.

In fact, contact crossings can be eliminated almost entirely, according to the author, by offsetting the leads. (See *Fig. 1d*)

An example of a circuit diagram, de-

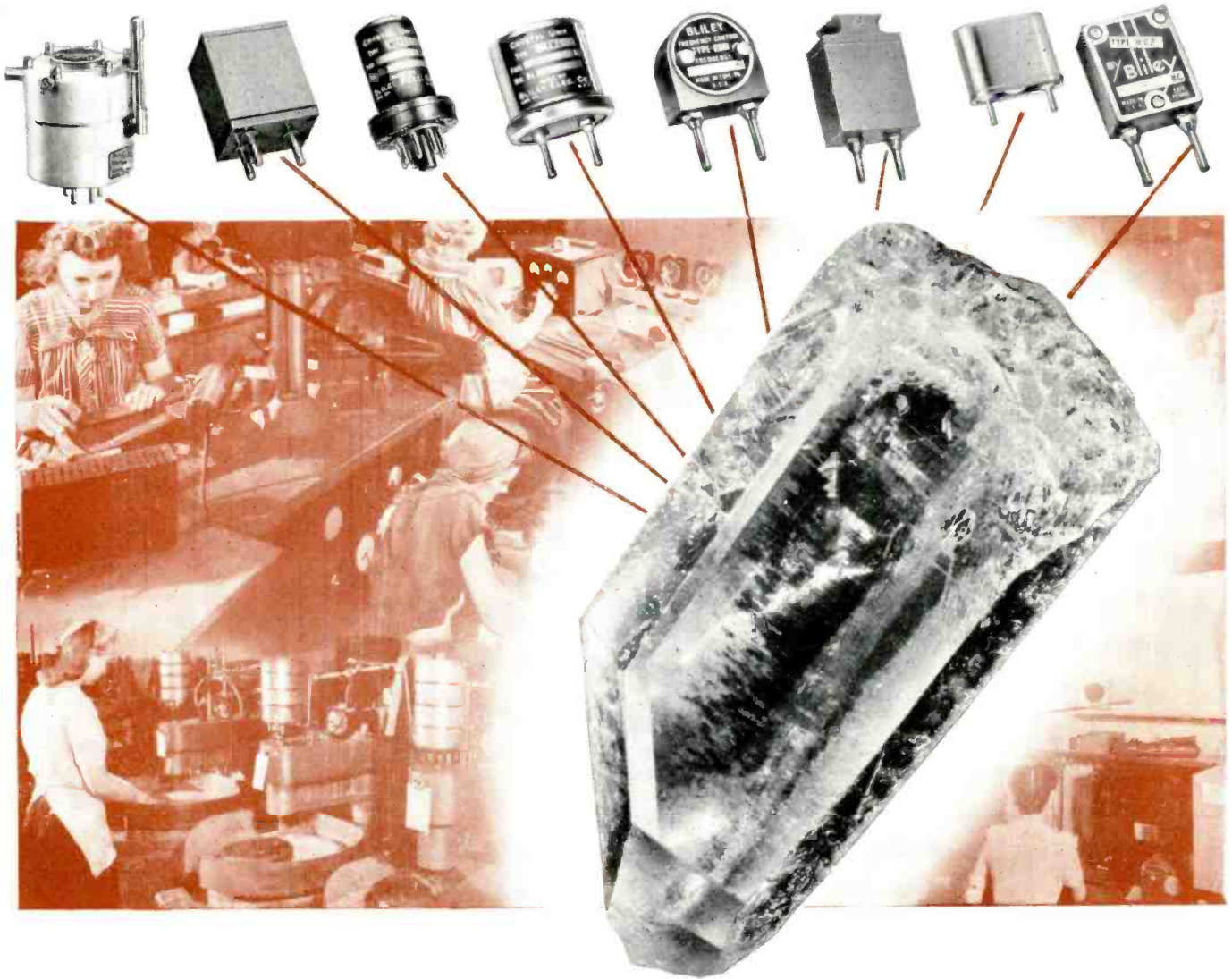

You name the application . . .

BLILEY has the crystals

Post VJ Day production of Bliley acid etched* crystals for FM receivers, Aircraft and Marine radios, Railroad communication equipment and many other applications is proceeding with the same skill and efficiency that marked our wartime operations.

Substantial quantities of these crystals are in the hands of foresighted manufacturers who planned in advance with Bliley engineers for frequency stabilization in their post-war models.

Now, more than ever before, you

need the versatile experience of Bliley engineers and craftsmen gained through more than 15 years of quartz crystal engineering exclusively. Whether your requirements are one crystal or a million, you can be sure of top quality—top design—and top performance—in Bliley crystals.

* * *

*Acid etching quartz crystals to frequency is a patented Bliley process.

Radio Engineers —
write for temporary
Bulletin RA-26



Another star has been added. Our 5th citation for outstanding achievement in producing materials essential to the war effort.

Bliley CRYSTALS

BLILEY ELECTRIC COMPANY • UNION STATION BUILDING, ERIE, PENNSYLVANIA

RADIO

★ SEPTEMBER, 1945

19

QUICK DELIVERY ON LEADING MAKES OF

WIRE & CABLE

for Radio and Power Use



STOCKS OF MANY TYPES ON HAND

Meeting urgent needs for Wire and Cable is a specialized job at ALLIED. From this one central source, shipments go constantly to industry, armed forces, government agencies and research laboratories. Here are gathered all leading makes, in all wanted types, for radio and power use.

BELDEN ALPHA LENZ CORNISH
ANACONDA CONSOLIDATED AMPHENOL

Power • Multi-Conductor • Solid and Stranded
Natural and Synthetic Rubber-Covered
Shielded • Indoor and Weatherproof • Coaxial
Transmitting and Receiving • Telephone
Microphone • Intercom • Hook-up • High-Tension
Magnet • Aerial • Twisted Pair • Lamp Cord

Large and varied stocks of Wire and Cable are maintained for *rush service*. Close contact with manufacturers expedites procurement. Whether your requirements be large or small—save time and work—call ALLIED first!

WRITE, WIRE, OR PHONE HAYMARKET 6800
for Everything in Radio and Electronics

Helpful
BUYING
GUIDE
Available
on Request
Write for it!

ALLIED RADIO CORPORATION

833 W. Jackson Blvd. • Dept. 14-J-5 • Chicago 7, Illinois

SUPPLIERS OF ELECTRONIC PARTS AND EQUIPMENT TO INDUSTRIAL AMERICA
Electronic Tubes, Rectifiers, Power Supplies, Intercommunicating Systems, Sound Systems, Photo-Cell Equipment, Batteries, Chargers, Converters, Generators, Supplies for Resistance Welders, Fuses, Test Instruments, Meters, Broadcast Station Equipment, Relays, Condensers, Capacitors, Resistors, Rheostats, Transformers, Switches, Coaxial Cable, Wire, Soldering Irons, Microphones, Speakers, Technical Books, etc.

TECHNICANA

[Continued from page 18]

lineated according to the author's conventions, is shown in Fig. 2.

It is noted that in the conventional circuit the speaker jack terminals are brought out to the line of terminals at the right, whereas the system proposed eliminates several horizontal lines.

COUNTING DEVICE

★ An electronic counter which employs a cold cathode trigger tube instead of the usual hot cathode tube has the advantage of longer life and therefore greater reliability. For industrial applications a large percent of servicing may be eliminated.

Such a counting device is described by Mr. L. Atkinson in the June 1945 issue of *Electronic Engineering*.

The circuit used, Fig. 3, illustrates a typical application in which interruption

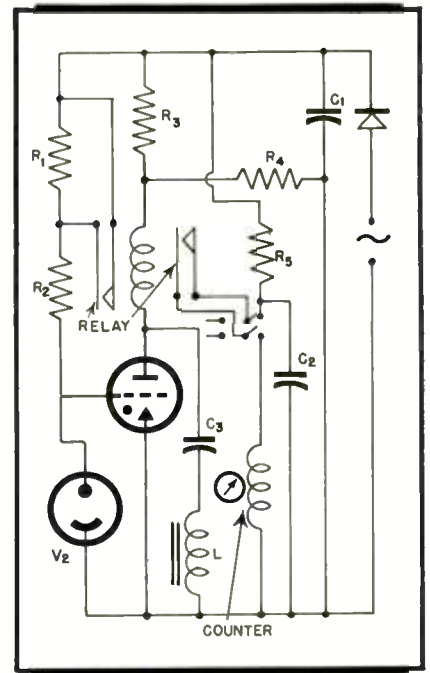

Figure 3

of a beam of light actuates the counter. It may be used with an automatic door opener, or burglar alarm, or with many other detection systems.

In this circuit the elements R_1 , R_2 , and V_2 form a voltage divider. Normally, with the light beam focused on the photocell V_2 , the grid of V_1 is slightly positive. When the beam is interrupted the resistance of V_2 increases and the grid of V_1 becomes more positive, causing the cold cathode tube V_1 to oscillate as a relaxation oscillator controlled by C_3 and L . The relay then closes two sets of contacts. The first set removes R_1 from the circuit and locks the action. The second set may either actuate the

**SPECIALISTS IN DESIGN
AND MANUFACTURE OF
FINE ACOUSTIC EQUIPMENT**

**NEW Jensen
PRODUCTS—
WATCH FOR COMING
ANNOUNCEMENT**

FREE to the Armed
Forces, Colleges,
Technical Schools,
Libraries.

PRODUCT NO. 1
PRODUCT NO. 2
PRODUCT NO. 3
PRODUCT NO. 4
PRODUCT NO. 5
PRODUCT NO. 6



5 MONOGRAPHS AVAILABLE

1. Loud Speaker Frequency-Response Measurements.
2. Impedance Matching and Power Distribution.
3. Frequency Range in Music Reproduction.
4. Effective Reproduction of Speech.
5. Worn Type Loud Speakers.

25c Each

THROUGHOUT the war JENSEN remained true to a more than fifteen-year-old tradition of specialization in the design and manufacture of fine acoustic equipment. Very shortly now this persistent adherence to specialization will again bring forth new and improved JENSEN Loud Speakers and related products. Their quality and performance ability, in the JENSEN tradition, will suggest their use by all who want the best. Watch for further announcements.



Jensen
SPEAKERS WITH

ALNICO 5

JENSEN RADIO MANUFACTURING COMPANY • 6615 SOUTH LARAMIE AVENUE, CHICAGO 38, ILLINOIS
IN CANADA—COPPER WIRE PRODUCTS, LTD., 137 RONCESVALLES AVENUE, TORONTO

NEW!

A complete,
24 page
Illustrated
Manual

on *Permanent Magnets*

**PERMANENT
MAGNETS**
for Industry

THE ARNOLD ENGINEERING COMPANY

147 EAST ONTARIO STREET, CHICAGO 11, ILLINOIS

**WRITE TODAY,
on your letterhead,
for your free copy.**

This unusual Arnold manual on permanent magnets is the product of many months of careful research and planning.

It is devoted entirely to the consideration of the factors affecting the design, fabrication and application of Alnico permanent magnets. Written entirely by Arnold engineers, its purpose is to help engineers in industry to better utilize the magnetic and physical characteristics of the Alnico alloys in arriving at efficient design.

Write today, on your letterhead, for your free copy.

THE ARNOLD ENGINEERING COMPANY

147 EAST ONTARIO STREET, CHICAGO 11, ILLINOIS

Specialists in the Manufacture of ALNICO PERMANENT MAGNETS

TECHNICANA

[Continued from page 20]

counter or an externally controlled mechanism, such as a motor.

With ordinary telephone type relays this circuit is said to be capable of recording up to 15,000 operations an hour.

In Fig. 4 a variation of the circuit of

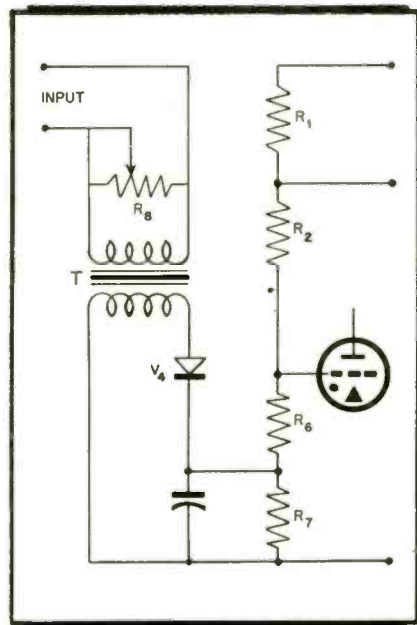

Figure 4

Fig. 3 permits recording the voltage variations in an external circuit. The external load changes are reflected in the voltage drop across R_7 . The rest of the circuit is identical to Fig. 3.

HIGH SPEED TRANSMISSION

★ Radio telegraphy using high speed tape operation records intelligence transmitted up to 3,000 words per minute. This speed is claimed for the Romac Radio Corporation's High Speed Telegraphic Unit briefly described in the July 1945 issue of *Wireless World*. The system was developed several years ago by a group of Polish radio engineers. It employs a new gas discharge relay tube, called the "Teleion" which corrects deformation of the keying pulses by restoring the square wave form at suitable points in both the transmitter and receiver.

The message is first prepared on paper tape, which is run past a photocell at high speed. The square-wave shape is restored to the resultant signal, in the "teleion" circuit, the sidebands are filtered out, and the signal is used to modulate the carrier direct.

In the receiver the signal, after amplification, is made to beat with a 5000-cycle local signal, and then passed through a 5000-cycle band-pass filter having a width of 1600 cycles. The selected signal band is then passed

Announcing...

NEWLY DESIGNED RADIART AERIALS

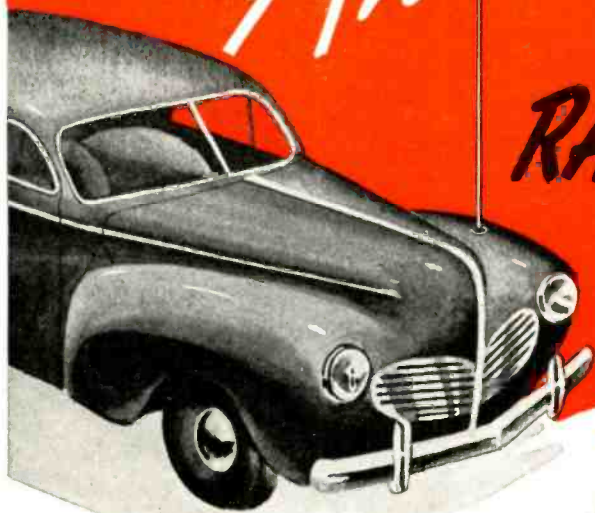

WITH FEATURES AND
ADVANTAGES THAT MAKE
THEM THE

Sensation of 1945!

This new RADIART Line is complete — 3 and 4 Section Models — to fit all cars — all angles — cowl, fender and under hood types — with waterproofed leads of new design featuring lowest capacity — high efficiency construction — with combination pin and bayonet fittings.

All models are made with only highest quality Admiralty brass tubing and stainless steel top section — thereby providing the maximum in

elastic load limit consistent with the utmost in strength and rigidity.

Newly designed method of mounting provides simplest form of one man installation — Mounting is completely waterproofed and impossible to short to the body.

And including those well known RADIART Features of the "Static" muffler magic ring and the permanent all-metal anti-rattler.

★ Check these RADIART advantages and features against all other aerial specifications and you will understand why RADIART AERIALS HAVE ALWAYS BEEN THE STANDARD OF COMPARISON.

Ask your distributor about deliveries of these new models.

MANUFACTURED BY THE MAKERS OF RADIART EXACT DUPLICATE VIBRATORS



Radiart Corporation

3571 W. 62nd STREET

Export Division
25 Warren St., New York 7, N.Y.

CLEVELAND 2, OHIO

Canadian Office
455 Craig St., W., Montreal, Canada

WORLD'S FASTEST PLANE *uses* ANDREW COAXIAL CABLES!



Lockheed's sensational new jet-propelled super fighter, the P-80 "Shooting Star," is the world's fastest and highest flying plane.

★ It is highly significant that Andrew coaxial cables were chosen for the vital radio and radar equipment installed in the P-80. They were selected because they are much more resistant than ordinary solid dielectric cables to the high temperature encountered in the tail of the plane.

Andrew Co. is a pioneer manufacturer of antenna tuning and phasing equipment, including a complete line of ceramic insulated coaxial cables and all necessary accessories. Write for catalog.

through a series of no less than eight limiters in which a-c and d-c limiting and automatic gain control are involved. Both top and bottom limiting takes place.

The "Teleion" circuit then restores the square wave form, which is used to modulate a 30-kc local oscillator signal. The recorder employs a piezo-crystal cutter for use with a form of wax cylinder which is run at 700 rpm.

The wax record is then run off in another machine at 12 to 35 rpm and the result is a carrier signal of 500 to 1500 cycles having a telegraphic record capable of being handled by a conventional tape recorder.

In the final recorder additional filtering is employed to remove record scratch and the "Teleion" tube is again used to provide a wave form (not necessarily square) suitable for the recorder pen.

SEE-SAW CIRCUIT

★ More on phase-splitting circuits, in the July 1945 issue of *Wireless World*, appears in a discussion of a modified paraphase circuit, called the "See-Saw Circuit". A circuit diagram is shown in Fig. 5.

Simplified, the arrangement breaks down to the basic circuit of Fig. 6, and the antiphase voltages, at points A and B, are the same as those of Fig. 5. In

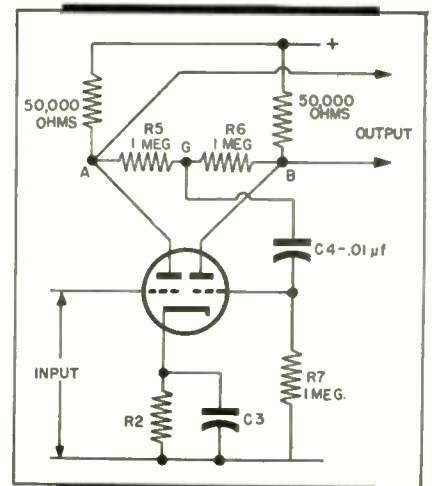

Figure 5

Fig. 6 the signal source, S, is itself the drive, at point A, for one of the push-pull output tubes. Point B is the drive for the other. Since S is in practice the output of a prior stage, this stage is included with that of the phase-splitting stage, by use of the double triode.

The see-saw circuit, as its name implies, is self-balancing. The 1-megohm resistors must be equal, within commer-

ANDREW
ANDREW CO.
363 EAST 75th STREET, CHICAGO 19, ILLINOIS



IN TUBE MANUFACTURE
 ALL SMALL DETAILS ARE **LARGE**
 TO *Federal*

From slender filament to anode block . . . *all* tube construction details, however small, are important to Federal. That is why this experienced and longtime manufacturer uses the illustrated high-magnification metallograph as part of its test equipment for checking raw material quality.

An example is the micro-photo inset. Here is shown oxide-free, high conductivity copper used for copper-to-glass seals . . . after the material has been reduced to a fine grain, non-porous structure through Federal's special metal-processing methods.

But whether copper, molybdenum or tungsten . . . they all are subjected to the same exclusive treatment and put through the same searching scrutiny . . . assurance that only the finest materials go to make up Federal tubes.

This exacting test is another good reason why Federal tubes are better tubes. Transmitting, rectifier, industrial power . . . they have a reputation that is deserved because they are *built to stay*.

Federal always *has* made better tubes.



Federal Telephone and Radio Corporation



Newark 1, N. J.



TECHNICANA

(Continued from page 241)

cial tolerances, and the μ of the tube must be reasonably high, 30 or 40.

The balancing effect is shown in Fig. 7, in which V_a represents the swing of

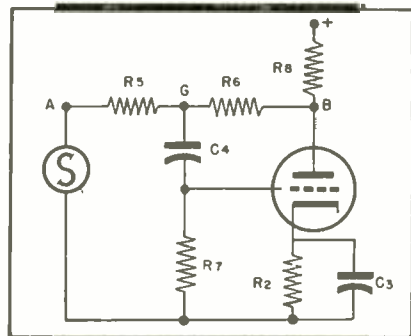

Figure 6

the input voltage at A , and V_b the anti-phase swing at B . If G were exactly zero there would be no input to the second half of the tube. A slight displacement, however, will provide sufficient grid excitation, in the correct phase, to develop the amplified antiphase output at B .

If the μ should be decreased slightly then the V_b swing would decrease and

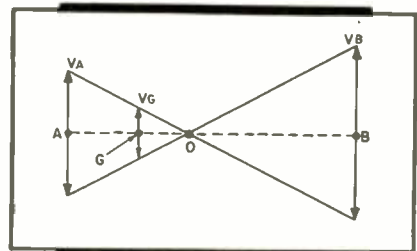

Figure 7

the fulcrum at O would move towards B . The swing at G would then increase, resulting in a greater swing at B —a self-balancing action. When R_5 and R_6 are exactly equal, then G is half way between A and B , and the fulcrum is slightly displaced to the right.

It is shown that when R_5 and R_6 are exactly equal the voltage unbalance, between A and B , will be less than 10% when the voltage amplification, M , of the phase-splitting tube is greater than 20, and that the voltage unbalance may be made exactly zero if $R_6 - R_5/R_5 = 2/M - 1$ where $M = V_a/V_p$. The value of M is approximately $\mu R_1/R_p + R_p$.

PIEZO-ELECTRIC CRYSTALS

★ An interesting investigation of materials for use as oscillating crystals is reported by Mr. C. P. Fagan, of Marconi's Wireless Telegraph Co., in the August 1945 issue of *Electronic Engineering*.

Mr. Fagan found that Potassium-
(Continued to page 29)

MR. RADIOMAN: You Can Use These "Tools" To Build a Better Job and a Secure Career in RADIO-ELECTRONICS

CREI Home-Study Training in Practical Radio-Electronics Engineering Combined With Your Own Experience Assures You of Job Security and an Interesting, Profitable Career.

What's ahead for you in the field of Radio Electronics? One thing is certain. Now that peace is here, Radio-Electronics will surge forth as one of America's foremost industries, offering promising careers for radiomen with modern technical training.

NOW is the time to take the time to prepare yourself for these important, career jobs in radio-electronics engineering. CREI can show you the way by providing you with the "tools" to build a firm foundation of ability based on a planned program of technical training.

In our proved home-study course, you learn not only *how* . . . but *why*! Easy-to-read-and-understand lessons are provided you well in advance, and each student has his personal instructor who corrects, criticizes and offers suggestions on each lesson examination. This is the successful CREI method of training for which more than 10,000 professional radiomen have enrolled since 1927.

Your ability to solve tough problems on paper and then follow-up with the necessary mechanical operation, is a true indication that you have the confidence born of *knowledge* . . . confidence in your ability to get and *hold* an important job with a secure, promising post-war future. Investigate now the CREI home-study course best suited to your needs, and prepare for security and happiness in the New World of Electronics! *Write for all the facts now.*



WRITE FOR FREE 36-PAGE BOOKLET

"Your Opportunity in the New World of Electronics"

If you have had professional or amateur radio experience and want to make more money, let us prove to you we have something you need to qualify for a better radio job. To help us intelligently answer your inquiry — PLEASE STATE BRIEFLY YOUR BACKGROUND OF EXPERIENCE, EDUCATION AND PRESENT POSITION.

CAPITOL RADIO ENGINEERING INSTITUTE

Home Study Courses in Practical Radio-Electronics
Engineering for Professional Self-Improvement

Dept. RA-9, 3224 - 16th Street, N. W., Washington 10, D. C.

Contractors to U. S. Navy—U. S. Coast Guard—Canadian Broadcasting Corp.
Producers of Well-Trained Technical Radiomen for Industry.

Member: NATIONAL COUNCIL OF TECHNICAL SCHOOLS



**20,000
VOLTS
IN A
2³/₈" BULB!**

ANOTHER "FIRST" BY NATIONAL UNION RESEARCH LABORATORIES

AN example of how war-time research by National Union engineers is helping to lay the foundation for vastly improved post-war Television, FM and radio reception, is this new half wave high vacuum rectifier—the NU 1Z2.

Here is a miniature with the voltage handling capabilities heretofore possible only in full size tubes. For a high voltage rectified supply in the operation of radar and television equipment, the NU 1Z2 saves space—operates with increased efficiency—is exceptionally rugged. Its low filament power consumption suggests many new fields in circuit design and application.

The NU 1Z2 joins a notable group of original electron tube developments by National Union Research Laboratories. For progress through research—count on National Union.

*National Union 1Z2
High Voltage Rectifier*

Inverse peak anode voltage-max.....	20,000 volts
Peak anode Current.....	10 ma.
DC Output Current.....	2 ma.
Filament Voltage.....	1.5 volts
Filament Current.....	300 ma.

The NU 1Z2 is designed to withstand shocks in excess of 500 G's.

Maximum overall length.....	2.70"
Maximum seated height.....	2.37"
Maximum diameter.....	.75"
Bulb.....	T5½
Base Miniature Button.....	7 pin
Mounting position.....	Any

**NATIONAL UNION
RADIO AND ELECTRON TUBES**

NATIONAL UNION RADIO CORPORATION · NEWARK 2, N. J.

A POSTWAR PROJECT FOR YOU...

SUPERSTANDARD RECEIVING TUBES

SUPERSTANDARD—above standard; a term coined by Hytron for a standard receiving tube completely redesigned to give improved performance in special electronic applications

● Receiving tube design is often a compromise. Ruggedness, dependability, long life—the very qualities most desirable in industrial electronics and aviation—have often been sacrificed for reduced cost and power consumption in broadcast receivers. Low filament current may be poor economy in an industrial tube. A standard 6SJ7GT may be objectionably microphonic in sound equipment. Vibration, jars, shocks, and inadequate maintenance in the factory may play hob with a standard receiving tube.

STANDARD — SPECIALLY SELECTED — NOW HYTRON PROPOSES SUPERSTANDARD

HYTRON IS CONVINCED: Standard receiving tubes are not right for special electronic applications. Special selection of standard tubes leads to embarrassing replacement problems—does not guarantee permanence of characteristics specially tested, long life, or suitability for operation at not-too-conservative maximum ratings. Hytron prewar ceramic-based low-loss GTX

tubes were but a step in the right direction. The Navy “ruggedized” tube program points the way. Complete redesign of many receiving tubes is mandatory. A tube listing at a dollar in electronic equipment costing thousands and controlling huge production lines is false economy which has already dealt industrial electronics many an unnecessary black eye.

MAY WE HAVE YOUR OPINION?

- 1 Do you agree that special selection merely results in replacement problems?
- 2 How many thousands of hours of life should **SUPERSTANDARD** tubes have?
- 3 What degree of vibration and shock should **SUPERSTANDARD** tubes be capable of withstanding?
- 4 For what characteristics not now tested should **SUPERSTANDARD** tubes be production tested?
- 5 Would you be willing to pay a premium price for **SUPERSTANDARD** tubes to attain trouble-free operation?
- 6 Should Hytron concentrate on developing **SUPERSTANDARD** tubes usable for many special purposes, and avoid trick and highly specialized tubes?
- 7 How closely should a **SUPERSTANDARD** tube adhere to fundamental characteristics of a standard receiving tube it supersedes?
- 8 Do you believe **SUPERSTANDARD** tubes should have special bases to avoid replacement by inferior standard receiving tubes?
- 9 Should **SUPERSTANDARD** tubes have new type numbers, or the old standard type numbers with a special suffix (e.g., 6SJ7GTS)?*
- 10 Have we omitted pertinent questions you believe important?

*NEMA and RMA are now working on type designation systems.

The Hytron **SUPERSTANDARD** tube is as yet an idea—a postwar project for YOU. You who use the tubes can spark the program—can make it come to life. Hytron will put its postwar engineering drive behind the **SUPERSTANDARD** tube, if you will help. Let us know the improvements of specific characteristics your experience has proved desirable. Drop a line today to our Commercial Engineering Department.

OLDEST MANUFACTURER SPECIALIZING IN RADIO RECEIVING TUBES

HYTRON

RADIO AND ELECTRONICS CORP.



MAIN OFFICE: SALEM, MASSACHUSETTS
PLANTS: SALEM, NEWBURYPORT, BEVERLY & LAWRENCE

TECHNICANA

[Continued from page 26]

Lithium Tartrate crystals can be grown in large size crystals, and that they have good mechanical strength, are extremely hard, and are unaffected by moisture.

Electrically the crystals have a low Q and a high negative temperature coefficient, so that they are not suitable for precision applications.

INDUCTION AND DIELECTRIC HEATING DATA

Data compiled by the Industrial Electronics Division, Westinghouse Electric Corporation, Baltimore, Maryland.

Dielectric Heating Formulas

1. CAPACITY OF A PARALLEL PLATE CAPACITOR

$$C = .224 \frac{e' A}{D} \times 10^{-12} \text{ (farads)}$$

C = capacity (farads)

e' = dielectric constant

A = electrode area (sq. in.)

D = distance between electrode (inches)

2. POWER INPUT INTO A DIELECTRIC

$$P_v = 1.41 f E_1^2 e'' \text{ (watts/cu. in.)}$$

P_v = power density

f = frequency (mc/sec.)

E₁ = kilovolts/in.

e'' = loss factor

3. "T" NETWORK EQUATIONS

$$R_a = X_1 + X_3$$

$$R_b = X_2 + X_3$$

$$-R_a R_b = X_1 X_2 + X_1 X_3 + X_2 X_3$$

R = resistance (ohms)

X = reactance (ohms)

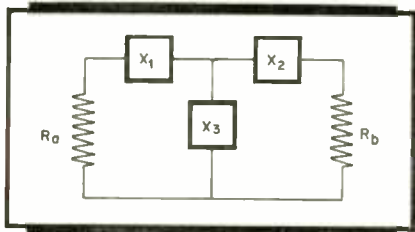

"T" Network Schematic

4. EFFECTIVE SERIES RESISTANCE OF A CAPACITOR

$$R = X \text{ (PF) ohms}$$

$$X = \frac{1}{\omega C} \text{ ohms}$$

$$\omega = 2\pi f$$

C = capacity (farads)

PF = power factor

5. DIELECTRIC LOSS FACTOR

$$e'' = (PF) \times e'$$

e'' = loss factor

PF = power factor

e' = dielectric constant

6. WAVE LENGTH ALONG ELECTRODES

$$\lambda = \frac{984}{f e'} \text{ (feet)}$$

λ = wave length (feet)

f = frequency mc/sec

e' = dielectric constant

[Continued on page 30]

Available NOW!

VHF RECEIVER KIT with New FM Band



88.6 to 107.6 Mc

115 to 140 Mc

ACORN TUBES • SEPARATE TUNING UNIT

Ideal for Communications Work, Instruction, Training, etc.

A unique 10 tube Concord Kit for FM-AM and VHF reception with a separate tuning unit employing the new acorn tubes. Circuit design is straightforward and simple with no frills or unnecessary components. Extremely compact, sturdy and easily assembled. Has only two controls on the front panel—the tuning control and the volume control. There's a standard headphone jack for output, a switch for change-over from FM to AM, and a power switch in the AC line.

Comes complete with all necessary parts including holes punched and all tubes, wire, solder, hardware, and detailed instructions. Chassis is 10" x 12" x 3" black finish. Dull black panel is 6 1/4" x 12" wide. Two models—CRC-130—Range 88.6 to 107.6 Mc (for the new FM Band), and CRC-140—Range 115 to 140 Mc. Quantity limited—while they last—Use coupon below to order today or to ask for literature giving detailed information and specifications. **\$54⁹⁵**

Complete with Tubes

CONCORD RADIO CORP.

LAFAYETTE RADIO CORPORATION

CHICAGO 7, ILL.

ATLANTA 3, GA.

901 W. Jackson Blvd.

265 Peachtree St.

CONCORD RADIO CORP.

901 W. Jackson Blvd., Dept. F-95, Chicago 7, Ill.

Please ship at once the Concord VHF Receiver Kit—or special descriptive literature—as checked below.

CRC-130—VHF Kit
Range 88.6 to 107.6 Mc

CRC-140—VHF Kit
Range 115 to 140 Mc

Send literature giving
details and specifications

Name.....

Address.....

City..... State.....



**THERMOSTATIC METAL TYPE
DELAY RELAYS
PROVIDE DELAYS RANGING
FROM 1 TO 120 SECONDS**

Other important features include:—

1. Compensated for ambient temperature changes from -40° to 110°F.
2. Contact ratings up to 115V-10a AC.
3. Hermetically sealed — not affected by altitude, moisture or other climate changes . . . Explosion-proof.
4. Octal radio base for easy replacement.
5. Compact, light, rugged, inexpensive.
6. Circuits available: SPST Normally Open; SPST Normally Closed.

WHAT'S YOUR PROBLEM? Send for "Special Problem Sheet" and Descriptive Bulletin.

AMPERITE CO. 561 BROADWAY
NEW YORK 12, N. Y.

In Canada: Atlas Radio Corp., Ltd.
560 King St. W., Toronto



TECHNICANA

[Continued from page 29]

7. DIELECTRIC HEATING IN AN AIR SPACE

$$E_1 = \frac{E}{t} \frac{G}{1 + \frac{G}{c'}}$$

E_1 = voltage gradient (kv/inch)
 t = thickness of work
 G = thickness of air space
 E = total voltage across plates (volts)
 c' = dielectric constant

8. CAPACITY OF PARALLEL PLATE CAPACITOR WITH PARALLEL LAYERS OF DIFFERENT DIELECTRICS

$$C = \frac{.224A \times 10^{-12}}{\frac{a_1}{e'_1} + \frac{a_2}{e'_2} + \dots + \frac{a_n}{e'_n}}$$

C = capacity (farads)
 A = electrode area (sq. in.)
 a_1 = thickness of first layer of dielectric (inches)
 a_2 = thickness of second layer of dielectric (inches)
 a_n = thickness of n th layer of dielectric (inches)
 e'_1 = dielectric constant of first dielectric layer
 e'_2 = dielectric constant of second dielectric layer
 e'_n = dielectric constant of n th dielectric layer

9. VOLTAGE GRADIENT IN ANY DIELECTRIC LAYER IN PARALLEL PLATE CAPACITOR WITH PARALLEL LAYERS OF DIFFERENT DIELECTRICS

$$E_1 = \frac{E \times 10^{-3}}{e'_k} \text{ Kv/in.}$$

$$e'_k = \left[\frac{a_1}{e'_1} + \frac{a_2}{e'_2} + \dots + \frac{a_n}{e'_n} \right]$$

E_1 = voltage gradient (Kv/in.) of layer considered
 E = total electrode voltage (volts)
 e'_k = dielectric constant of dielectric layer considered
 a_1 = thickness of first layer of dielectric (inches)
 a_2 = thickness of second layer of dielectric (inches)
 a_n = thickness of n th layer of dielectric (inches)
 e'_1 = dielectric constant of first dielectric layer
 e'_2 = dielectric constant of second dielectric layer
 e'_n = dielectric constant of n th dielectric layer

HIGH FREQUENCY HEATING

★ High-frequency heating hits a new peak in the August 1945 issue of *Electronic Engineering* with a series of four major articles on this subject. In addition there are four shorter articles and a two-page bibliography covering the field back to 1942.

In "High-Frequency Dielectric Heating", A. E. L. Jervis reviews some of the applications with particular emphasis on the laminating of wood. He reproduces already published curves for the time-temperature relationships for various thicknesses of spruce, showing the

No. 51N

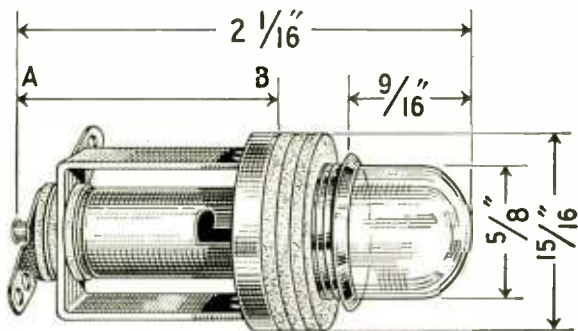

Length A to B: 1/4"

New NEON Assembly With Plastic Dome

The clear, colorless, plastic dome . . . a feature of the new Drake No. 51N permits the Neon glow to be observed from all angles. This new assembly accommodates the NE51 Neon glow lamp which gives longer life, (3,000 hrs.) low power consumption (1/25 watt) and shock-proof construction. A built-in resistor permits direct connection

to 115 volt circuits. Furnished with three 1/16" thick fibre spacing washers which are removable when unit is mounted in thick panels thus keeping Neon glow at top of dome. The New No. 51N is only one of many fine Drake Socket and Jewel Light Assemblies; many incorporating patented features developed by our research staff. Do you have an up-to-date Drake catalog?



SOCKET AND JEWEL LIGHT ASSEMBLIES

DRAKE MANUFACTURING CO.

1713 WEST HUBBARD ST., CHICAGO 22, U.S.A.



Quiet

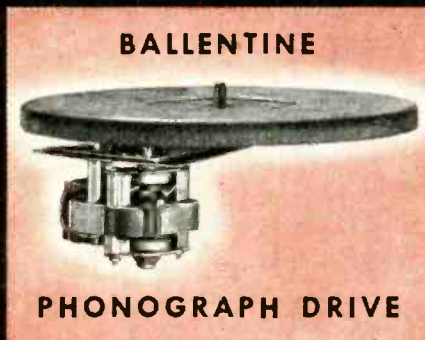

Efficient—reliable—above all, *QUIET*—
that's the Ballentine Phonograph Drive.
Basic refinements in design, *precision*
dynamic balance, the most advanced
manufacturing technique and equipment make
the Ballentine Phonograph Motor unequalled
for low background noise or rumble.
Send for descriptive bulletin.

RUSSELL ELECTRIC COMPANY
370 WEST HURON ST., CHICAGO 10, ILL.
Manufacturers of
BALLENTINE PHONOGRAPH DRIVE

LEO'S SPECIAL!

Immediate Delivery

Money Back Guarantee on this all-purpose

Multitester

Handles AC and DC Voltmeter, DC Milliammeter, High and Low range Ohmmeter. Size 5 1/2 x 8 x 3 3/4. 3" meter with sturdy D'Aronson's movement. Write for priority information.

EVERYTHING IN TEST EQUIPMENT We have it or can get it. Preferred delivery, quick service on all makes, all types. Hundreds of new items on order. Buy from Leo, W9GFQ.

See Leo for WRL Radio Kits priority required



Model WRL 300 ONLY \$18.75 Less Leads



Photo Amplifier Kits Complete with tubes, instructions No. 1059... **\$9.50**

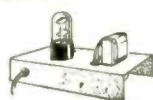

Code Oscillator Kits Complete with tube. Size 3"x6". No. 66-200 **\$4.95**

PLACE YOUR ORDER NOW!

Leo is making delivery now on **HALLICRAFTERS** For preferred delivery, easy terms, and liberal trade in allowance write Leo W9GFQ.

DUAL FIL. TRANSF. Fully Shielded

110 V. Tapped Primary. Secondary, 5 volt @ 3 amp. and 6.3 V.C.T. @ 4 amp. No. 9-551... **\$2.25**

EXCLUSIVE AT LEO'S!

- 44 Page Parts Flyer... **FREE**
- Packed with hard-to-get items. Immediate delivery to radio repairmen. Usual priorities. Experimenters write Leo, W9GFQ, on how to get radio repair parts.
- Tube and Circuit Reference Book10c
- Handy Tube-Base Calculator25c
- Giant Radio Reference Map, Size 3 1/2 x 4 1/2 ft 15c



MAIL TODAY

Wholesale Radio Laboratories
714 West Broadway R-9
Council Bluffs, Iowa

Please rush Multitester No. 300, \$18.75 is enclosed, or Enclosed is \$____, Balance C.O.D.

Here's 10c, Send "Tubes and Circuits" Book.

I want a Tube-Base calculator. 25c enclosed.

Ship me your radio map. 15c enclosed.

Send me your free flyer of hard-to-get radio parts.

Name _____

Address _____

Town _____ State _____

I am an amateur; experimenter; service man.

QUICK SERVICE

Your order will receive my own personal attention. You'll get "same day" delivery service from the heart of the nation . . . on anything in radio.

Sincerely,
Leo & Meyer W9GFQ



Wholesale RADIO LABORATORIES

TECHNICANA

[Continued from page 30]

advantages of high frequency heating over the older methods of heating.

The theory of dielectric heating is reviewed, and formulae are presented which may be used in calculating power and voltage requirements for various types of materials.

Dielectric Heating

A. J. Maddock, of Standard Telephones and Cables, Ltd., in an article entitled "Calculations for Dielectric Heating by High Frequency Current", presents a heating chart, reproduced here in Fig. 8.

The theoretical basis for the curves on the chart is identical to that used

frequency of f megacycles and r-f voltage E . K is the dielectric constant of the material, $\cos \varphi$ the power factor, ρ the relative density, and d the thickness of the material in cm., with no air gap between electrodes. The two formulae are related by the expression $t = 60 W_o/P_o$, which gives time in minutes to produce temperature rise θ_c .

A pair of similar formulae gives the energy in watt-hours/cu. in. and power in watts/cu in., with other values in °F., inches and BTU's. The corresponding chart also employs the second set of units.

Study of the power formula shows that the voltage gradient, E/d , squared, is more important than the frequency when it is desired to increase the power and reduce the heating time.

In Fig. 8, quadrant A gives the relationship between temperature rise, θ_c ,

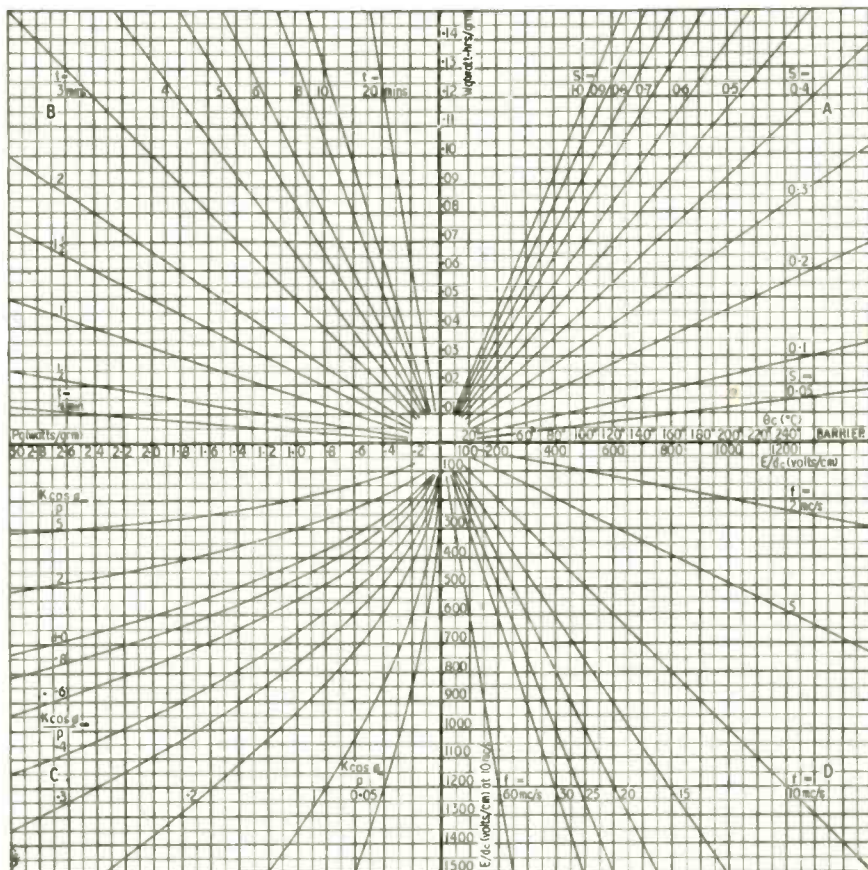

Figure 8

by Mr. Jervis, above, except for the choice of units of measure. Mr. Maddock's energy formula is $W_o = 1.16 \times 10^{-3} \cdot S \cdot \theta_c$ watt-hours/gram, in which W_o is the energy per gram required to heat a dielectric material placed between two plane parallel electrodes, S is the specific heat of the material in cal/gm/°C, and θ_c the temperature rise in °C. The power formula is $P_o = 5.58 \times 10^{-7} \cdot f \cdot (E/d)^2 \cdot \frac{K \cos \varphi}{\rho}$ watts/gm, in which P_o is the power required, at a

and energy, W_o , for various values of specific heat, S . By proceeding to quadrant B the energy, W_o , may be converted to power, P_o , for various values of t . The power value P_o , in quadrant C, is related to voltage gradient, E/d , for different values of $\frac{K \cos \varphi}{\rho}$. In quadrant D the voltage gradient is adjusted for different frequencies. It is not permissible to cross the barrier between quadrants A and D, but otherwise [Continued on page 78]

relays

IN THE TRAFICOUNTER

The Streeter-Amet Trafficcounter tabs 900 or more overlapping cars per minute at split second contact. As car wheels hit a pneumatic tube stretched across traffic lanes the compression closes an electrical contact on a diaphragm, operating a Guardian relay. The relay responds to every impulse but the Trafficcounter registers only every other impulse to compensate for rear wheel contact.

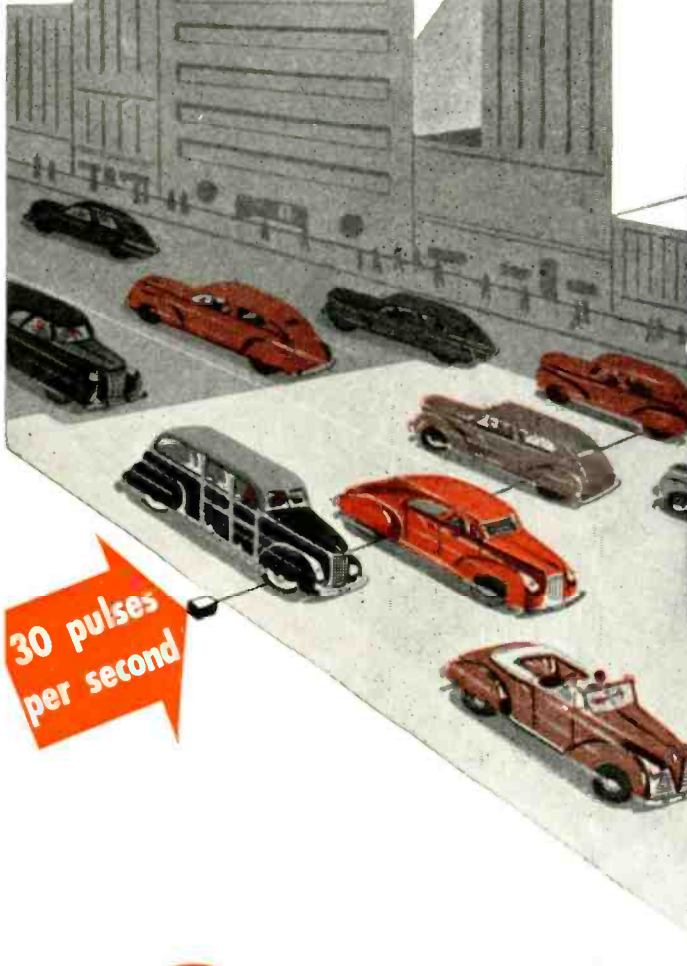

30 pulses per second

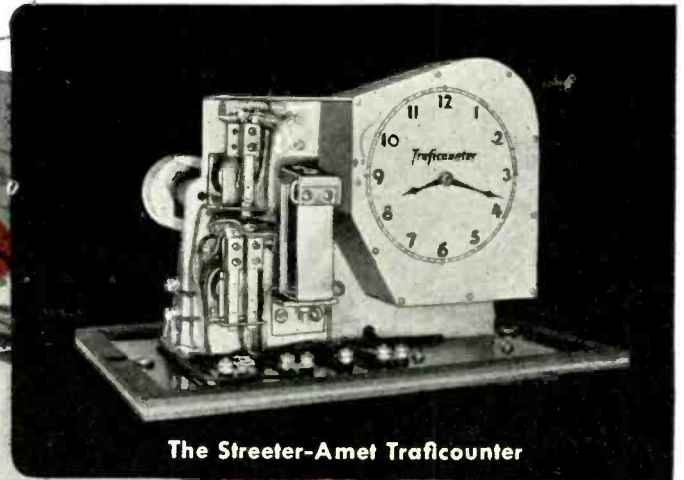

The Streeter-Amet Trafficcounter

How *Relays* BY GUARDIAN Count 900 or More Cars per Minute

A grueling job . . . faithfully responding to 1800 or more impulses per minute, hour after hour in rain, heat, and cold the year 'round. For this job Streeter-Amet engineers use Guardian's 6 volt d-c relay, Series 125.

Here is an example of an application that ordinarily calls for a specially built relay. Yet Streeter-Amet finds Guardian's standard relays good enough, dependable enough, and fast enough to do their special job. They save money by buying a standard unit. They get quicker delivery. And they have the comforting knowledge that replacements parts are immediately available if and when needed.

If your application appears to be a "special" it may pay you to look over Guardian's standard relays first. And write us. Guardian engineers will recommend the relay most suitable for your application. If a "special" is really needed they'll help you design it economically.

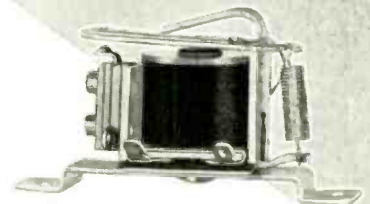

Series 125 d.c. relay

Also—iron clad and laminated solenoids, stepping relays, magnetic contactors, electric counters, snap and blade switches.

GUARDIAN  **ELECTRIC**
 1605-K W. WALNUT STREET CHICAGO 12, ILLINOIS
 A COMPLETE LINE OF RELAYS SERVING AMERICAN INDUSTRY

And now . . .

MYCALEX

410

PRECISION-MOLDED

*Newest and Greatest Advancement
in Low Loss Insulation*

Just as sound advanced motion pictures and as television is advancing radio, so the new improved MOLDED MYCALEX will advance the cause of electronic engineers who seek ever-higher standards in insulating materials.

New and exclusive methods of MYCALEX CORPORATION now enable us to mold MYCALEX to far more exacting specifications . . . closer tolerances, with metal inserts molded in and other refinements.

Our technique affords a virtually endless variety of irregular shapes that compare with molded plastics for smoothness and precision. Yet MYCALEX offers so much more in electrical and physical advantages.

For example: greater strength and dimensional stability, freedom from cold flow, freedom from carbonization, imperviousness to moisture and gases . . . ability to withstand temperatures beyond 400 C.

Investigate the new uses and applications of this remarkable new advancement in MYCALEX. Get the facts about MYCALEX 410.



MYCALEX CORPORATION OF AMERICA

"Owners of 'MYCALEX' Patents"

Plant and General Offices, CLIFTON, N. J.

Executive Offices, 30 ROCKEFELLER PLAZA, NEW YORK 20, N. Y.

Design Considerations In Small Receivers

A. C. MATTHEWS

Successful methods of co-ordinating electrical design features with production requirements to reduce costs are discussed in detail in this article

THE DESIGN of small home type receivers, including portables, is probably one of the most difficult assignments a design engineer can receive. Such a statement might possibly be disputed, unless all the factors involved are carefully considered. It is true that almost any design engineer, with a minimum of practical experience, can successfully arrange a circuit and a suitable mechanical layout which will meet certain established performance characteristics. However, the ability to evolve a design for a small receiver which can be built in production quantities without excessive rejects and with a minimum of labor costs, requires a great deal of experience. It is the intention of this article to point out some of the problems normally encountered, and so far as possible, to suggest solutions which should prove satisfactory. It must be realized that each new design presents different problems, although basically they are usually quite similar.

The small home receiver and the portable are both definitely in the lower price bracket but this does not mean that they can be inferior in performance or appearance. Probably the only characteristics not strictly comparable to those of higher-priced receivers are power output and tonal fidelity. Granting the fact that most small models are purchased as a second or third receiver in the home, it is also true that the customer will be influenced by its tonal quality, so, unless the tone is pleasing to the ear the public acceptance of the unit will probably not come up to expectations.

Fidelity of reproduction, then, is one of the primary considerations for the designer. Obtaining a satisfactory balance between tone and cost requires

careful circuit analysis and the elimination of all unnecessary components which do not directly contribute to the desired result. This is only one of the problems confronting the small set designer. For example, others are appearance and convenience of operation (these items are of more concern to the sales department, although the method of attaining them affects the design), Underwriters' requirements, heat dissipation in small cabinets, ease of assembly, wiring and testing, ease of servicing, and last but not least, cost.

It is evident that all these require-

ments cannot be easily satisfied. A thorough knowledge of basic radio design, together with an understanding of production assembly and testing technique, a knowledge of standardization of parts and the legendary thriftiness of a Scotsman are all required of a successful small receiver designer.

Procedure

A design-assignment sheet should be written by the engineer if such is not already available from the sales or other department charged with the responsibility of setting up the necessary requirements. This should indicate the number of tubes, probable selling price or cost (whichever is the most familiar to the engineer), size of cabinet, weight, power output, desired controls and any other pertinent data which might assist the engineer in visualizing the completed receiver.

It is important that the design engineer have as complete a picture as possible of what is expected of the completed design. Some companies make use of artist sketches or mock-up models during preliminary discussions with the engineering department. In this way the designer can actually see the "thinking" of the powers that be. Oftentimes this eliminates the building of several preliminary models before the final design is evolved. It also permits the design engineer to criticize the proposed product if he feels that it would be impractical to attain. For instance, if a proposed design required the control knobs and dial scale be located in such a position that it would require "trick" driving mechanisms which the designer felt were impractical, then the engineer could voice his opinions or doubts and an agreement could be reached as to

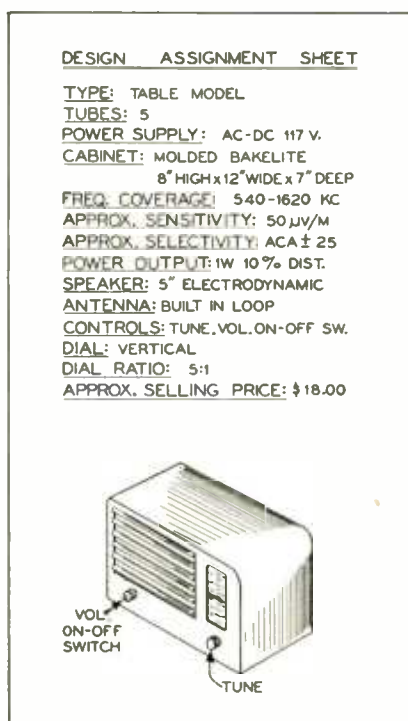

A typical design assignment sheet which places the specifications for the receiver in convenient form for analysis

whether or not it would be worth the time and effort to investigate the problem.

Such action not only promotes good will and fine co-operation between design sections (product, cabinet, mechanical and electrical), but usually results in a much better product, so far as production is concerned. Compromises can be made until all are satisfied or it is agreed (after considering all angles) the proposed design is practical and should prove satisfactory for production.

Preliminary Schematic

After agreeing on the general design points, the next step is to make a preliminary wiring diagram such as shown in Fig. 1. This should include data as to voltages and currents required, approximate gain and selectivity per stage and power output. At this time we are not yet concerned with final tonal fidelity, except for the specification of the speaker size which should have been decided when the assignment sheet was written. In other words, the audio portion of the circuit should be more or less standard, without extra bass boosting or other special circuits. The preliminary wiring diagram should be as simple and basic as is possible to conceive. All unnecessary parts should be omitted for three reasons, (1) parts cost money, (2) every part is a potential source of trouble during the life of the receiver, (3) extra components require additional labor and time during production. This is probably the basic difference between small and large receiver design since in the latter extra features are included as a matter of course.

Having decided on a suitable circuit, the next step is the choice of components. It must be decided, for instance, whether the tubes should be of the miniature or the more common GT or Loktal types. Miniature tubes have little to offer in the way of advantages in the small home set, since they are generally slightly more costly and they save little actual space. This may appear an odd statement, since there is quite a difference in physical size between the two types of tubes. However, in the small home receiver the speaker is usually large compared to the other parts on the chassis, and when adequate clearance is provided for it and the other necessary parts, it will be found in the majority of cases, the use of miniature tubes will save very little space.

This obviously is not the case when designing personal portables because, with this type receiver, the speaker is ordinarily quite small and it is possible to arrange the mechanical layout in such a manner that a considerable sav-

ing in space results. When miniature tubes become more plentiful and production costs are reduced it is probable that the small set designer will automatically specify them if only in the interests of standardization.

Regardless of whether miniature, loktal or GT construction is chosen the designer should now be in a position to specify the actual tube types.¹ Certainly the tubes to be used in a small receiver should be on the Preferred List² because of their availability in large quantities, and because in general they are low in cost. The contemplated tube types should be included on the preliminary schematic diagram.

Other miniature components such as volume controls, variable condensers, i-f transformers, etc., are now available and can be specified if decreased performance is acceptable. For example, in order to obtain the necessary capacity in a miniature tuning condenser it is necessary to use thin plates with close spacing. Such a unit can not be expected to maintain its original alignment and it certainly is susceptible to deterioration if dust or other extraneous materials lodge between the plates. In other words, if miniature components are contemplated, make sure their life characteristics are satisfactory.

Mechanical Layout

With the tentative schematic and the components decided upon the next step is the mechanical layout. This part of the design is carried on by both the

electrical and mechanical design engineers. Templates for tube sockets, transformers, tuning condenser, speaker and other large components are often employed at this point. These are moved around on an outline of the chassis sub-base until a suitable arrangement satisfactory to both engineers is obtained. Compromises must often be made at this point in the interests of convenience for wiring, assembly, feedback, etc. If possible, the mechanical layout should follow the electrical wiring; that is, the converter should precede the i-f amplifier, etc., along to the speaker.

Obviously every design will not be this simple because the assignment sheet may call for the speaker to be in the center of the chassis, or perhaps the tuning condenser must be driven directly with a knob on its tuning shaft or any number of other arrangements that only sales departments or others responsible for the external appearance can devise. (An engineer's opinion only.) In such cases the mechanical layout may become quite involved and every possibility must be considered, such as the location of parts so that coupling between leads or parts is avoided, unless previous experience indicates no trouble will result.

Adequate clearance must be allowed to prevent one component from interfering with another under all conditions of tolerances. It is impossible to run a receiver down a production line if clearances are so small that it is

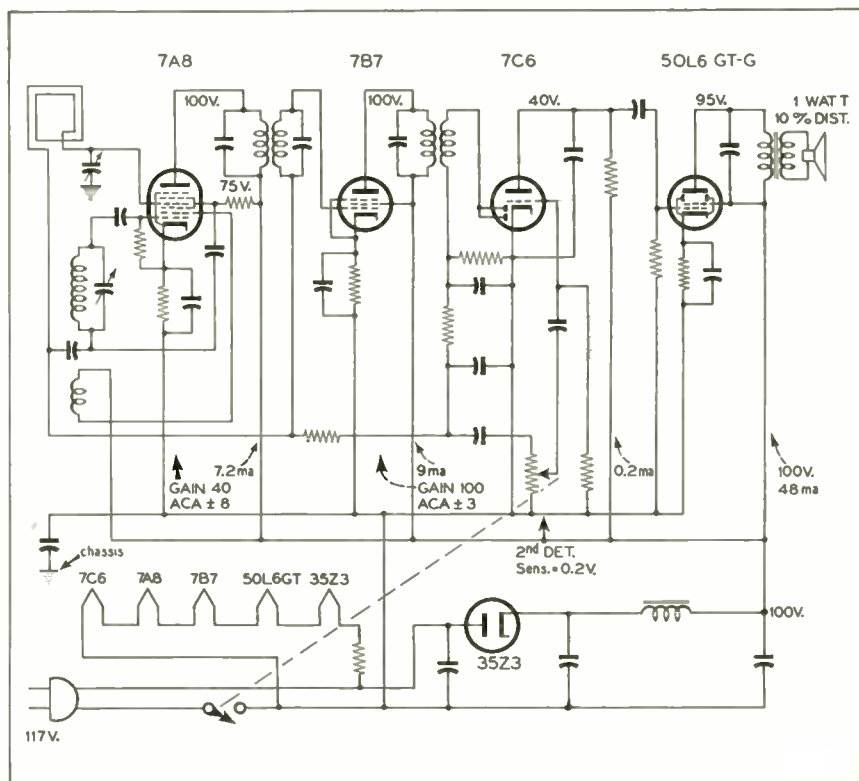

Fig. 1. Preliminary schematic of a small receiver, showing estimated voltages and currents

necessary to select certain high and low tolerance parts in order to assemble the unit. This is not only true of parts put on during the initial assembly but is also true during wiring operations.

Once a rough chassis layout is obtained the next step is to draw, front, top and end views of the proposed unit including the inside of the cabinet. This may make necessary slight revisions, because it is very easy to overlook clearances in height when arranging the parts on the chassis layout. If everything fits, a final detail of the chassis can then be drawn; otherwise changes are made until the mechanical layout in the cabinet is satisfactory.

In detailing the chassis, provision should be made for wiring panels and lugs. Sockets should be oriented in such a manner that leads are short and as far as possible out of the way. Long leads are a nuisance during wiring operations since they seem always to get into spots where they cause regeneration or instability. If long leads are necessary they should be "dressed" in such a manner that they do not interfere with subsequent wiring operations or do not cause electrical trouble. Small flexible "dress" lugs are often provided on the chassis or other parts to securely anchor such leads in position.

Another common mistake is not allowing for sufficient wiring panels. Three or four wires are about the maximum that can be easily connected to a single terminal or lug, as more are difficult to handle in production and are

definitely a handicap, if for any reason a part must be removed after the unit has been wired.

In general, it is more economical to add an extra lug to a wiring panel strip than to solder more than four wires to it. This is not always the case, because some units are so small physically that the addition of an extra terminal is impossible.

Provision for adequate ventilation, especially in ac-dc operated receivers, should be considered since this factor will often influence the overall layout. The method of ventilation selected must not violate the requirements of the Underwriters' Laboratories.

General Design

Before going into any detailed discussion of electrical design technique the problem of using standardized parts should be considered. Much has been and will continue to be written on this subject, and until the design engineer, or the company with which he is employed makes a serious effort to specify standardized parts the program as a whole cannot fully succeed. A lack of co-operation, whether intentional or through ignorance, only results in higher priced but not higher quality components. Furthermore, valuable time on the part of the engineers, standardization groups and organizations is to a large degree wasted.

Standardization can only apply to certain components, in fact it should

only concern those parts which do not affect the individuality of the design. If all receivers looked and performed alike there would be no incentive for the design engineer to continually strive for improvements, progress would be stifled, and the desire on the part of the public to purchase new models before they were actually needed would cease to exist. For these reasons and for reduction of costs the present standardization program should be encouraged to the fullest extent by design engineers who are in a position to specify components.

The initial development sample is built on a chassis which has been detailed from the mechanical layout. It is good practise to provide four, instead of just two, mounting holes for the sockets on the first chassis. This permits a socket to be oriented in four positions instead of the usual two positions and is often helpful when, for some unforeseen reason, it becomes desirable to orient a socket to avoid a difficult wiring situation.

It might be added at this point there are two schools of thought as to how the first sample should be built. Some engineers feel a sort of pictorial diagram should be made which locates every component and wiring point required before actually building the first sample; others maintain more can be accomplished by actually assembling a sample which has as many wiring panels, ground lugs, etc., as is possible to locate physically within the chassis without excessive crowding.

The latter method is unquestionably the best procedure if the engineer has had some previous design experience. Instead of having first to sketch the layout (incidentally, such sketches must be nearly to scale, otherwise trouble will be encountered) and then actually duplicating it, both operations can be combined with a considerable saving in time. Working with actual parts which have three dimensions is considerably more revealing than working with a two dimensional sketch which lacks perspective.

As mentioned previously, all unnecessary parts should have been omitted when the schematic was drawn. However, during the early development it may be found that some additional parts are required and for such contingencies it is advisable to provide additional wiring panels throughout the chassis. These can be omitted when the second sample is built if it is found they are not required.

One of the important factors in the design of small receivers is the time required for various production operations. If parts are inaccessible and wiring is extremely difficult it not only costs more per unit but the total volume

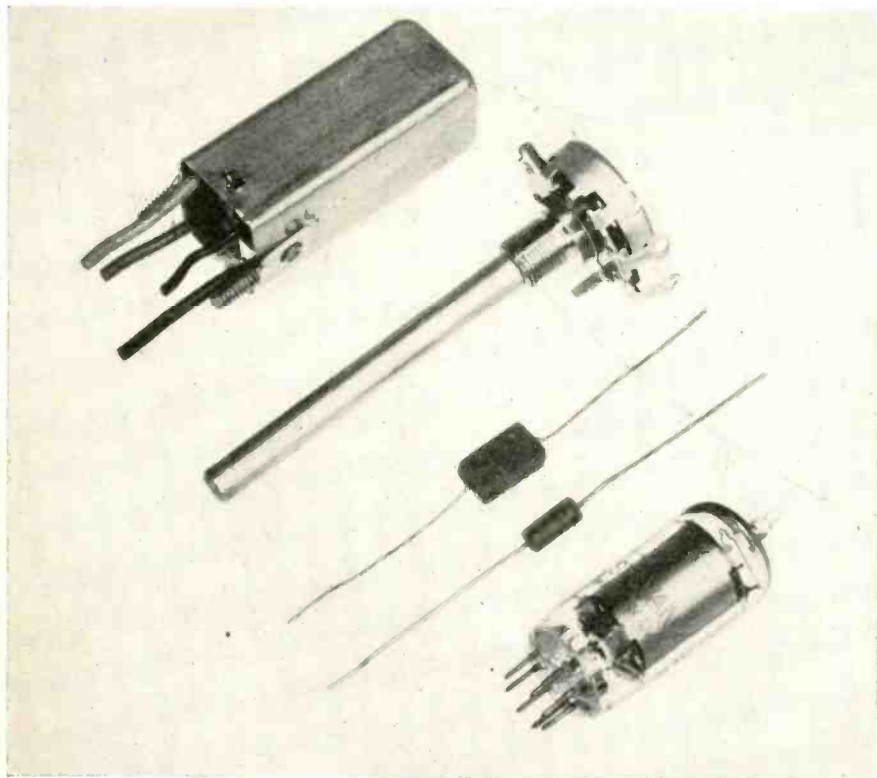

Typical components used in the construction of small receivers

of production per day is decreased. This obviously reflects on the overall cost by increasing the overhead charges per unit. Of course, most manufacturers have time study and factory control departments whose duty it is to keep production costs and associated problems at a minimum, but when a change in wiring or assembly is desired it is usually necessary to obtain an approval from the design engineer before authorizing the change. Since this requires additional time and adds to the overhead it is important that the designer take these factors into consideration.

Unfortunately, the space available in a small receiver makes it sometimes necessary to wire the unit in layers, where some components or wiring are covered by other parts. This type construction, while it is difficult for the engineer since he usually wires the set according to a schematic, is not too difficult for production if it is well laid out. If the components on the bottom layer can be completely concealed and soldered before the other parts are added, and furthermore if the latter parts do not need to be connected to the previously used terminals, the design is usually satisfactory from a production standpoint. If for some reason the unit does not pass test, this type of construction will obviously require more repair time, but if the above precautions are observed and rejects are low (which they should be) the cost of this type construction is justified by the saving in space.

The use of additional wiring lugs to facilitate wiring is a problem that has no definite answer, because in some cases it is entirely feasible to solder five or even more leads to a single terminal, and in others, due to the particular location, more than three wires are a distinct handicap. Each design must be studied separately and the cost of an extra terminal weighed against the inconvenience of wiring. In general, four wires can be successfully soldered to one wiring panel lug, while socket terminals being smaller are usually limited to three.

Another point to be considered is to provide adequate test points to facilitate production testing. Here a compromise must be made between cost on the one hand and time saving on the other. It must be remembered that skilled operators whose base rate or hourly pay is higher than the average production worker are usually required for testing receivers; if then, the addition of a test lug or terminal will result in an appreciable saving of time it might well be included in the design. This is particularly important when production methods make use of a moving conveyor belt and the testing is carried out without removing the unit from the

belt. Obviously a design which decreases the testing time will permit running the conveyor belt at a higher speed with a proportional increase in output.

It is the seemingly small details such as the above that make the design of small receivers a difficult assignment.

After completing the wiring, the sample is connected to its power source and checked for voltages and currents. This is only a preliminary check, since the receiver may not yet be operating properly. It is assumed that center values have been used for all electrical parts and that the power supply voltage is correct. Later it will be necessary to ascertain the allowable tolerances on the parts and it is always advisable to employ standard values—especially those values which are obtainable in a wide range of tolerances—because the wider the tolerance, the lower the cost.

Assuming the voltages are approximately correct and that the receiver is of the superheterodyne type, the next step is to connect the measuring equipment and then adjust each stage step-by-step to the desired characteristic. Since measurement technique has been adequately covered elsewhere it will not be necessary to discuss it in detail at this time.³

Audio Section

The audio section of the small receiver is usually quite orthodox, in that it ordinarily consists of an output tube, speaker, power supply and combination voltage amplifier-second detector-a.v.c. stage. As a precaution, the preceding tubes are disconnected from the "B" supply and a compensating resistor is temporarily connected across the high voltage supply to simulate the load of the unused tubes, otherwise distortion and hum may result. These two characteristics are of major importance in the design of the audio section and incidentally are the most likely to give trouble.

It is assumed that an output tube has been chosen which has a high power sensitivity and that the voltages and output impedance are according to the recommendations of the tube manufacturer. The grid resistor and coupling condenser should be chosen to give the desired frequency response when being driven by the audio voltage amplifier. In arriving at these values, cognizance should be taken of the maximum grid input resistance recommended by the tube manufacturer; allowance being made for the tolerance decided upon (usually $\pm 20\%$). The lower the resistance value the greater the load imposed on the preceding audio stage and consequently the lower the voltage gain. It is desirable then to choose as high a value as permissible provided hum is not encountered.

Another precaution when using a high grid resistor is to specify a good quality grid coupling condenser since any leakage across this condenser will result in a loss of grid bias on the output stage. The leakage resistance of most coupling condensers is quite high under normal atmospheric conditions but when high humidity is encountered an inferior grade of condenser will decrease in leakage resistance to such an extent that the control grid of the output may become positive. Operation under such conditions obviously would soon damage the receiver.

Hum

In ac-dc power units (the greatest majority of small receivers are of this type), there are many causes of hum. The principal sources are due to (1) insufficient filtering of rectifier voltage, (2) unbalance of power line, (3) hum voltage in the speaker field induced into the voice coil, (4) heater-cathode leakage, (5) stray electromagnetic or electrostatic fields.

With such limited space available the main power supply filter is sometimes designed to a minimum and R-C filters used wherever necessary. Such procedures are only justified when a savings in overall cost can be shown, otherwise it is customary to use large filter capacitors.

The magnitude of the hum is sometimes definitely changed by reversing the line plug. If the hum is negligible when the line plug is inserted a certain way, no additional filtering is usually employed. Should the minimum hum due to an unbalanced power line be objectionable, it can be eliminated by by-passing each side of the line to the chassis with a 0.1 μ fd condenser. Ordinarily only one condenser is used in small sets, and this is connected directly across the line. Its principal function is to prevent modulation hum which is only present when a signal or carrier is being received.

Hum originating from ripple voltage in the speaker field being induced into

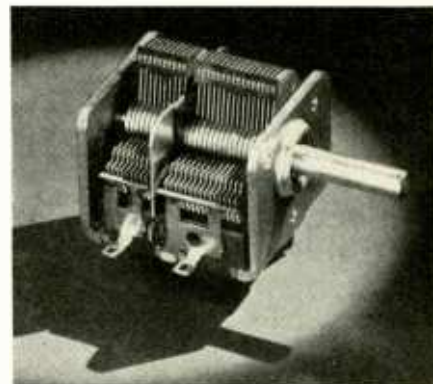

Miniature tuning condenser
(Courtesy General Instrument Co.)

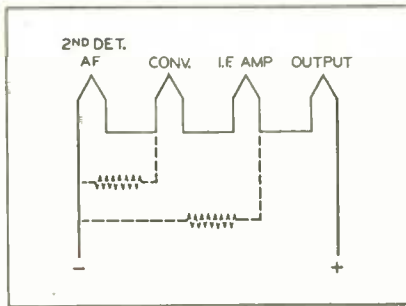

Fig. 2. Series heater connections for minimum hum. Dotted connections are for filament type tubes, where the plate current is appreciable compared to the filament current

the voice coil may be effectively nullified by the use of a hum bucking coil on the speaker. This consists of a few turns of wire wound around the pole piece adjacent to the field coil and connected in series with the voice coil. Its polarity of course should be such that the hum in the voice coil is cancelled.

Series operation of filaments often causes hum due to cathode-heater leakage. This can be reduced to a large extent by arranging the sequence of connections in such a manner that those tubes most subject to hum have their heaters nearest the low potential side of the plate supply voltage. In general, connections are as shown in Fig. 2; dotted lines indicate additions for series operation of filament type tubes where the plate current is an appreciable part of the filament current. Without these by-pass resistors the plate and screen currents will add to the normal filament current and produce abnormal filament voltages which will materially shorten the useful tube life.

Hum due to stray fields can largely be eliminated by separating those parts or circuits carrying a-c voltages as far as possible from parts or circuits carrying the signal. The speaker field, rectifier tube, and line cord are the most common sources of such trouble.

The first step in the elimination of hum is to isolate its source by first shorting the input and then the output of each stage; starting with the output tube plate and working back through the second detector. If the hum persists when the output plate is shorted this indicates the trouble is due to ripple in the speaker field being induced into the voice coil.

Distortion

Distortion present in the audio section of the receiver may be the result of mismatch of impedance in the output stage, incorrect operating conditions, hum or distortion from a previous stage. The latter can be due to several design weaknesses and will be mentioned when these sections (i-f, 2nd detector and converter) are discussed.

A common source of distortion in the

audio voltage amplifier when using a high- μ triode is due to the value of the grid input resistor employed. The value of the grid resistor may vary from one to 15 megohms and is therefore not extremely critical, assuming a by-passed cathode resistor of the correct value is used. If it is desired to operate the tube at zero bias and save the cost of the cathode resistor and condenser, then the value of the grid resistor becomes more critical if high gain and low distortion are to be obtained. A comparison of the gain and distortion with and without zero bias of a typical high- μ triode is shown in Fig. 3.

With the preliminary audio design completed, the next step should be to test the second detector. The volume control, which is generally a part of the 2nd detector-audio stage should be isolated from the diode circuits even though this requires additional parts. This is because high resistance controls are likely to become noisy if d.c. (from the diode) is permitted to flow through them.

The diode transformer should be single tuned with primary and secondary closely coupled for maximum efficiency. Double tuned transformers give more selectivity but are not often employed in small receivers because for the additional cost involved, only a slight improvement in performance is obtained. The choice of the diode load resistor and associated components, and the proportioning of the a-c to d-c ratio to obtain low distortion with high percentage modulated signals are so well known that further discussion is not required. It is only mentioned because it is a possible source of distortion that should not be overlooked.

I-F Amplifier

The i-f system in a small low-priced receiver usually consists of one i-f amplifier tube with its associated input and output transformers. The tube usually chosen is an pentode of medium G_m (approx. 2000) having a remote cut-off grid characteristic.

Present-day i-f transformer design makes it practical to obtain gains of the order of 50 to 90 per stage. Ob-

viously with gains of this magnitude adequate shielding must be employed. Zinc and aluminum are both extensively used for this purpose. Where space is at a premium the usual $1\frac{3}{8}$ " square transformer may be replaced by the smaller $\frac{3}{4}$ " or 1" can. These transformers differ somewhat from the larger units in that the inductances are enclosed in powdered iron shields which confine the field of the inductance so that the proximity of the smaller can has little effect on the losses.

Regeneration in the i-f system may be caused by several factors, among which are the grid-plate capacity of the tube, poorly located leads, inadequate shielding, and common coupling in the power supply a.v.c. or ground circuits. Any of these are likely to be of sufficient magnitude to produce an asymmetrical selectivity curve since the circuits are regenerative on one side of resonance only.

A typical selectivity curve with regeneration, and with regeneration partly eliminated is shown in Fig. 4. A small amount of regeneration may sometimes be desirable because of the additional selectivity obtained, but unless it is kept within bounds the receiver may be difficult to tune or instability is likely to result. Of the above mentioned possible sources of regeneration, the grid-plate capacity of the tube is the least important. Neither should the high potential signal leads prove too troublesome unless the mechanical layout is such that they are extremely long. In such cases it might be necessary to resort to shielded wire for making the connections. Good shielded r-f wire is expensive; furthermore, it is difficult for production use, so every effort should be made to eliminate it by designing the layout to avoid such wiring.

Shield cans are not by any stretch of the imagination perfect. It is therefore necessary to keep the i-f transformers separated, otherwise these can be a source of regeneration. A 0.020" thick shield will be adequate if the transformers are separated by a tube or an equivalent spacing. In some stubborn cases it may be necessary to use several small holes in the chassis for the leads instead of one larger opening which might permit undesirable coupling between the coils and some other part.

Regeneration due to common coupling in the power supply, a.v.c. or ground circuits is readily understandable. By-pass condensers and isolating resistors properly employed will largely eliminate such trouble but they should not be used indiscriminately as this adds unnecessarily to the cost; however, if the by-pass condenser is properly connected at the correct point the circuit very few will be required. In other words, the low side of the condenser should not be

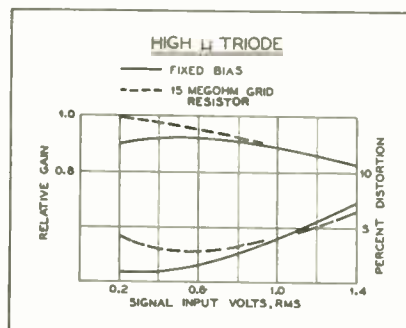

Fig. 3. Gain-distortion curves for zero- and fixed-bias operation

merely connected to any convenient ground or chassis point, but should be connected in such a manner that the current will not flow through devious paths in order to complete the circuit. Correct grounding of components is one of the finer points in the design of receivers and should be treated as such.

Converter and Antenna Circuits

Practically all small receivers make use of a pentagrid converter. This is a logical choice, because in general only the regular broadcast band is to be covered and noise is not too important. It also combines the mixer and oscillator in one envelope with a resultant saving in cost. In an a-c/d-c series-connected heater circuit the converter tube should be placed near the negative end of the tube lineup to prevent excessive modulation hum which will distort the signal. The plate and screen voltages should be adequately filtered for the same reason.

No particular trouble is normally experienced with the converter stage at broadcast frequencies. The gain at r.f. should be approximately 70 per cent of that obtained when using the tube as an i-f amplifier.

The input circuit of the converter normally takes the form of a high impedance loop antenna, thus eliminating the need for an antenna coil and the use of a short wire for signal pickup. Low impedance loop antenna systems are seldom used because they are inherently more costly than the high impedance type. More care and ingenuity are required to obtain optimum performance with a built-in loop since with the small space available and the fact that the loop is in close proximity to the chassis it is impractical to obtain high Q .

Each design requires separate treatment and for this reason no given set of rules can be laid down which will be satisfactory for all cases. The following suggestions, however, should prove useful. The signal pickup is proportional to the area of the loop times the number of turns and the Q . For this reason the first loop should be made as large as the cabinet will permit. Solid wire is usually employed and every effort should be made to keep the distributed capacity to a minimum, either by using a skeleton wooden frame, or in the case of pancake loops, by employing some sort of open winding. The completed assembly should be made impervious to moisture by impregnation.

The decrease in Q when the loop is placed near the chassis is not the only factor to be considered. Coupling between the loop to the i-f system may prove to be particularly undesirable because of stability reasons. This shows up as oscillation at the low frequency

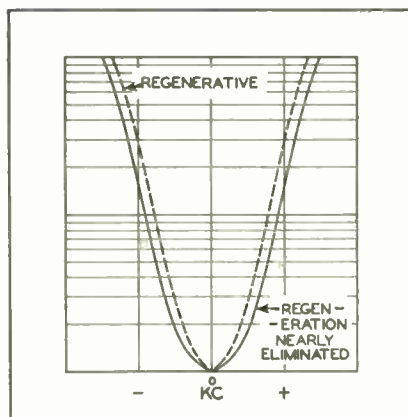

Fig. 4. Effect of regeneration on selectivity curve

end of the band, where the signal frequency approaches that of the i-f amplifier. Some instability may also be noticed at harmonics of the i.f. The direction of the loop winding can be reversed if this occurs, although this will result in degeneration and loss of sensitivity. Shielding the i-f tubes and coils will go a long way in correcting such instability and incidentally will also improve the whistle modulation at the 2nd and 3rd harmonics of the i.f.

Listening Test

With the overall receiver completed and installed in its cabinet a preliminary listening test is made since up to now nothing has been decided as to tonal fidelity. The audio section of the receiver was designed for fairly uniform response but no effort was made to put the finishing touches on it since this would require a knowledge of such unknown factors as cabinet resonance and speaker characteristics. These, particularly the latter, can be varied over quite a wide range and it is for this reason no special effort need be made to design for final tonal fidelity before the preliminary listening test.

During the test, which should be made in the home rather than the laboratory, the engineer should endeavor to consider himself as a prospective customer. Checks should be made at normal, high and low line voltages for overall stability, ease of tuning (freedom from regeneration), spurious signal response, sensitivity, selectivity and finally hum, distortion and pleasing tone. With the exception of fidelity all these characteristics are subject to measurement and for this reason should be satisfactory as originally designed. Fidelity too can be measured acoustically but unless sound pressure curves are thoroughly understood they are no substitute for actual listening tests.

Several speakers, having different resonant points, should be available and if possible duplicate cabinets with dummy chassis should be arranged in

such a manner that it will be possible to switch the receiver to any one of the cabinet-speaker combinations. The usual procedure is to choose by elimination; that is, when a particular speaker does not sound promising it is discarded. Even then the receiver may not come up to expectations and it will be necessary to alter the fidelity by electrical methods. Synthetic bass or a peak at some particular point may be desired, or perhaps a slowly rising characteristic will give a more pleasing tone. Changes are made in the values of the audio components or additions are made which more nearly result in the desired response.

The receiver should then be set up and another comparison made between the most promising speakers, listening to programs having both speech and music. Quite often one combination will sound better on speech while another will be more pleasing on music and therefore a compromise will be required. Do not hurry this listening test because it often happens that a receiver will sound entirely satisfactory on one type program while on most others it will not be so pleasing. If you can listen to the receiver for an entire evening at home without being unduly disturbed it is likely that the tonal fidelity is satisfactory. What seemed like brilliance on a short listening test may turn out to be quite annoying if listened to for a considerable length of time. When the customer purchases a receiver he must listen to it for a long time and if it does not sound well he will probably hesitate to purchase a new receiver of the same manufacture.

If, during the listening test, no radical changes are required the design is complete and ready for attaching appropriate labels, tags, etc. and be turned over to production. Should the test indicate extensive changes are required it will then be necessary to repeat most of the preliminary listening tests after a more final sample is available.

Labels and Instructions

After the receiver has been designed and approved the matter of labels and instructions should be considered. Labels, to most engineers, are usually just an annoyance. They are, however, very important and serve a useful purpose in creating good will. The model, serial number and tube layout labels obviously are useful to both the dealer and customer as a means of identification and an aid in the replacement of tubes. The Underwriters' label is important because it gives the customer a feeling of confidence to know the receiver has been approved for his protection. The patent label, of course, is mainly for the manu-

[Continued on page 83]

Effect Of Dielectric Materials On Inductor Performance

A. C. THOMPSON

Engineering Dep't., Zenith Radio Corp.

This article provides data to guide engineers in selecting coil impregnants, coil forms for inductors, and capacitors for use in resonant circuits. Charts of typical cases are supplied to aid in obtaining quick solutions of problems frequently encountered

IT IS THE PURPOSE of this article to explain the mechanism of dielectric losses in an inductor, to derive several formulae useful in computing the effects in which we are interested, and to present graphs of typical cases which may aid in obtaining quick solutions for average cases.

This article is intended for use as a guide in selecting coil impregnants and coil forms for inductors and in selecting capacitors for use in resonant circuits.

Information Required

It is assumed that the following information is at hand:

1. The operating frequency of the inductor being considered.
2. The dielectric constant and the power factor of the material to be used as dielectric media or the power factor of the capacitor to be

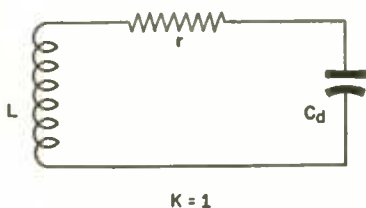

Fig. 1. Equivalent circuit of a bare wire, single layer solenoid in which its field is not appreciably affected by dielectric or shielding media

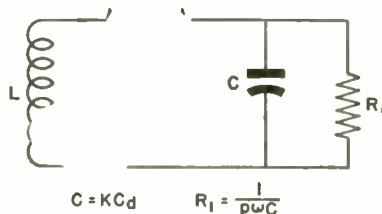

Fig. 2. Equivalent circuit of an inductor on whose field the dielectric medium has maximum effect

used (at the approximate frequency being considered).

3. The value of the inductance of the inductor and its distributed capacitance.

Theory

It is assumed that addition to an inductor of a dielectric with an appreciable loss or of a capacitor with a poor power factor will result in a reduction of the resonant circuit figure of merit, Q . In addition, the presence of a dielectric material with a dielectric constant greater than that of air (or, in some cases, greater than that of the wire insulation) will increase the distributed capacity of the coil.

Single Layer Solenoid

As an illustration let us choose an inductor which is a single layer solenoid made of bare wire spaced between turns.

If the inductor is sufficiently removed from surrounding materials that its field is not appreciably disturbed by any dielectric or shielding media, its equivalent circuit will be shown in Fig. 1. The distributed capacity, C_d , represents the capacity due to adjacent turns.

If this coil were then subjected to the influence of some dielectric medium the distributed capacity would increase by some factor and a loss would be added. For the purposes of this report it has been assumed that the dielectric media added to the inductor are added in such a manner that all the lines of force of the inductor, when it is energized, are contained in the dielectric media. This case represents the maximum possible influence of the dielectric media on the coil. All derived formulae and charts in this report are based on the above assumption.

Maximum Effect of Dielectric Materials

Fig. 2 shows the condition which obtains when a dielectric medium has its maximum effect on the inductor. A practical case which nearly fulfills this condition would be obtained if the solenoid referred to above were moulded in mica-filled bakelite so that the material completely surrounded the solenoid.

[Continued on following page]

Definition of Terms Used

1. *ASTM Definition of Dielectric Constant (K)*

The equivalent parallel capacitance of a capacitor with the material as a dielectric at a specified frequency to the capacitance of the same capacitor in a vacuum.

2. *ASTM Definition of Dielectric Power Factor (p)*

The cosine of the dielectric phase angle θ where

For cases of a power factor < 0.1 the tangent is substantially equal to the power factor.

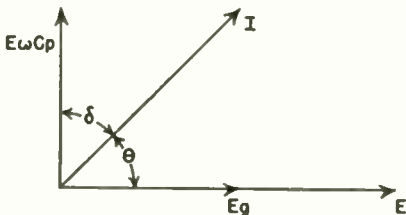

Vector diagram of dielectric phase angle

3. *TERMS*

K = Dielectric Constant

p = Power Factor — if the power factor is given in percent, $p = PF \times 100$

K_1 = Figure of Merit of a Dielectric Material

L = Inductance in henries

C_d = Distributed Capacity of the inductor

C = For an inductor: $C = C_d \times K$
For capacitor: $C = C_1 + C_d$

C_1 = Capacity of external capacitor used with the inductor

R_1 = Shunt Resistance — from the definition of power factor

Q = The final figure of merit of the coil and added losses as in Fig. 2

Q_1 = Original Figure of Merit of the inductor, as in Fig. 1

r = Original Series Loss of the inductor as shown in Fig. 1

R = Equivalent Shunt Resistance of r .

A more rigorous solution, useful for any type of inductive circuit, is also given in the appendix. The equivalent shunt resistance:

$$R = \frac{\omega L(Q_1^2 + 1)}{\omega^2 L p C Q_1^2 + p \omega^2 LC + Q_1} \dots (2)$$

Resonant Circuit Q by this method:

$$Q = \frac{(Q_1^2 + 1)}{\omega^2 L p C Q_1^2 + p \omega^2 LC + Q_1} \dots (3)$$

It should be noted that C and KC_d are used interchangeably, depending upon whether it is a condenser or a dielectric media which causes the loss.

Charts

The charts shown may be used to give an indication of the effects of dielectric media of different figures of merit for typical coils which cover the range from 100 kc to 275 mc. The dielectric constant and the power factor are usually specified at 1 kc, 1 mc, and 30 mc. The values for the frequency nearest the range of the inductor under consideration should be chosen. The correct chart may be chosen if the value of inductance is known. If the distributed capacitance of the inductor under consideration differs greatly from that listed on the charts, a new computation should be made.

The charts were based on formula (1) and the coils in Table 1. The coils were measured to determine their inductance and distributed capacitance.

Chart V was plotted from the data used for charts I through IV. The curves are rather arbitrary and are useful only to present an idea of the influence of frequency on inductors surrounded by dielectric media of various power factors.

No chart was made to show capacitor p.f. vs. tuned circuit Q since the use of capacitors of poor power factor is unusual. The calculation can readily be made from formula (1) or formula (3).

When the charts are used to evaluate the effect on an inductor of a dielectric medium the Q values represent the worst possible case since the values

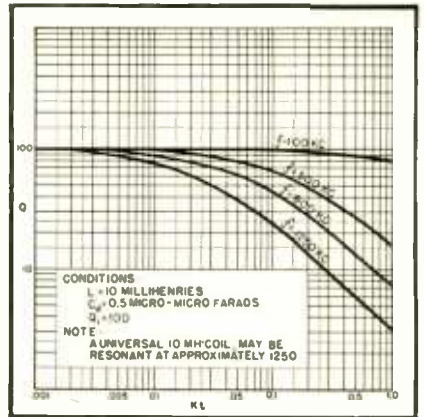

CHART I
Dielectric material figure vs. merit Q curves for a 10-millihenry coil with the indicated constants and self-resonant at approximately 1250 kc

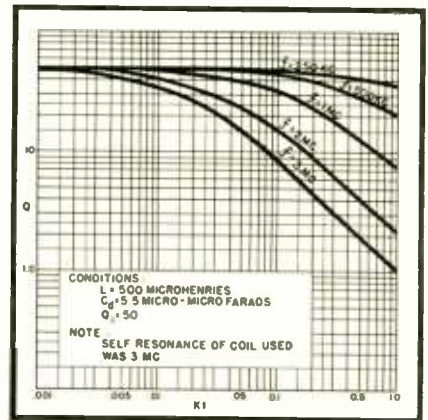

CHART II
Dielectric material figure of merit vs. Q curves for a 500 microhenry coil self-resonant at 3 mc. Original coil Q equalled 50

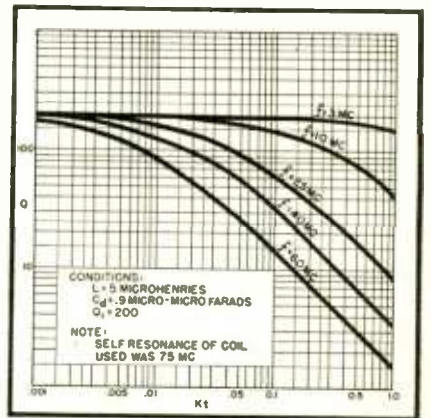

CHART III
Dielectric material figure of merit vs. Q curves for a 5 microhenry coil self-resonant at 75 mc. Coil Q originally equalled 200

Formulae

It is possible to derive several mathematical relationships between Q and K_1 . The mechanics of the derivations are shown in the appendix. The formula (1) given below is valid for $Q > 10$ when the circuit is a resonant circuit.

$$Q = \frac{Q_1}{K_1 Q_1 C_d \omega^2 L + 1} \dots (1)$$

TABLE 1

Type Coil	L	Useful Range	Tuning Capacity	
Universal	10 mh	50 kc - 1250 kc	1000 μ fd - SR*	I
"	500 μ h	220 kc - 3 mc	1000 " - SR	II
Solenoid	5 μ h	3.2 mc - 75 mc	1000 " - SR	III
"	0.5 μ h	10 mc - 275 mc	500 " - SR	IV

*Self Resonance

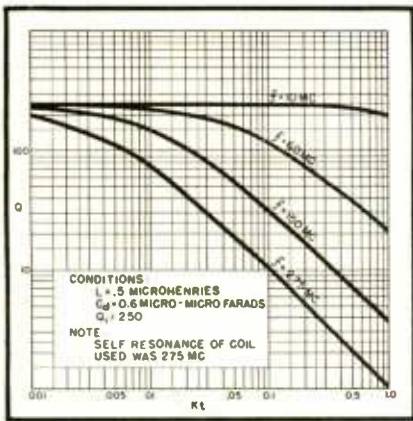

CHART IV

Dielectric material figure of merit vs. Q curves for a 5-microhenry coil, self-resonant at 275 mc, whose original Q was 250

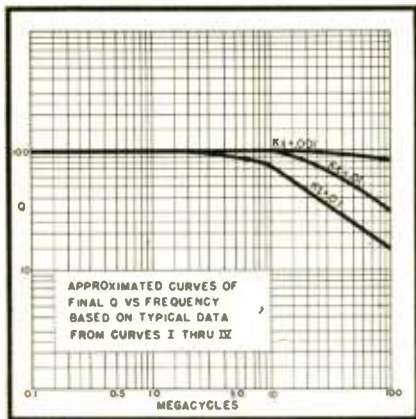

CHART V

The dielectric material figure of merit affects the final Q of the inductor to the degree indicated on this chart at frequencies from 0.1 to 100 mc

plotted were based on the assumption that the lines of flux of the energized inductor are confined to the dielectric media.

The Effect of a Coil Form

When a coil is wound on a form which is made of a material which has a high power factor, the coil being later impregnated with a material of low power factor, the total reduction in Q will not be as bad as the value found from the charts based on the power factor of the form material. This, of course, is because all the lines of force of the inductor do not cut the coil form.

The effect of a coil form was studied by the use of the coil indicated for Chart IV. This coil consisted of 11 turns of #12 bare tinned wire 1" long with a 1/2" I.D. Measured in air the coil had a Q₁ of 250. With a 1" x 1/2" O.D. form of BM-120 inserted the Q dropped to 173. Chart IV indicated a Q of 87. The drop in Q due to the coil form was, then, roughly half of the drop which would be expected if all the lines of force of the inductor were confined to the BM-120.

Appendix

Derivation of the simplified expression relating dielectric figure of merit and coil figure of merit. This derivation is valid for Q > 10 of a resonant circuit.

Q is defined as $\frac{X}{r}$ which involves the series resistance. The expression for Q at resonance involving R equivalent is derived as follows:

$$Z = \frac{(-jX_c)(r + jX_L)}{r + j(X_L - X_c)}$$

at resonance $X_L = X_c$

$$Z = \frac{X^2}{r} + \frac{r(-jX_c)}{r} \text{ and}$$

$$R \text{ eq. } r = X^2 \text{ then } Q = X \cdot \frac{R \text{ eq.}}{X^2} = \frac{R \text{ eq.}}{X}$$

If the dielectric material presents a loss, that loss may also be considered as a resistance shunted across C, thus:

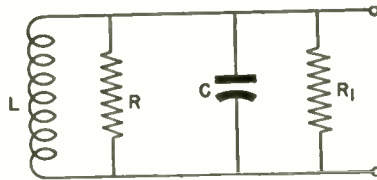

A more rigorous formula which gives R for any type of inductive circuit is derived below: (See diagram at right)

$$Y_T = \frac{1}{r + jX_L} + \frac{R_2 - jX_c}{-jX_c R_2}$$

$$= \frac{jX_c R_2 + R_2 r - jX_c r - jX_L R_2 + X_L X_c}{-jX_c R_2 + X_L X_c R_2}$$

Multiplying by the conjugate

$$Y_T = \frac{X_L X_c + R_2 r + j(X_L R_2 - X_c r - X_c R_2)}{X_L X_c R_2 - jX_c R_2 r}$$

$$\frac{X_L X_c R_2 + jK_c R_2 r}{X_L X_c R_2 + jK_c R_2 r}$$

$$G = \frac{X_L^2 X_c^2 R_2 + X_c^2 R_2^2 + X_c^2 R_2^2}{X_L^2 X_c^2 R_2^2 + X_c^2 R_2^2 r^2}$$

substitute $R_2 = \frac{1}{\rho \omega C}$ $r = \frac{\omega L}{Q_1}$

$$G = \frac{\frac{L^2}{C^2} \cdot \frac{1}{\rho \omega C} + \frac{1}{\omega^2 C^2} \cdot \frac{1}{\rho \omega C} \cdot \frac{\omega^2 L^2}{Q_1^2} + \frac{1}{\omega^2 C^2} \cdot \frac{1}{\rho \omega C} \cdot \frac{\omega L}{Q_1}}{\frac{L^2}{C^2} \cdot \frac{1}{\rho^2 \omega^2 C^2} + \frac{1}{\omega^2 C^2} \cdot \frac{1}{\rho \omega C} \cdot \frac{\omega^2 L^2}{Q_1^2}}$$

If the form of (a) is correct, then

$$Q = \frac{R \text{ eq.}}{X} = \frac{R R_1}{R + R_1} = \frac{1}{\omega L}$$

by definition $R_1 = \frac{1}{\rho \omega C}$

also, as shown above $R = Q_1 \omega L$

$$Q = \frac{Q_1 \omega L \cdot \frac{1}{\rho \omega C}}{\omega L + \frac{1}{\rho \omega C} \cdot \frac{Q_1 \omega L}{Q_1 \rho \omega^2 L C + 1}}$$

$$Q = \frac{Q_1}{Q_1 \rho \omega^2 L C + 1} \text{ where } C \text{ is the condenser capacity}$$

For use with a dielectric media, $C = K C_0$

$$\text{then } Q = \frac{Q_1}{K_1 Q_1 C_0 \omega^2 L + 1} \dots \dots \dots (1)$$

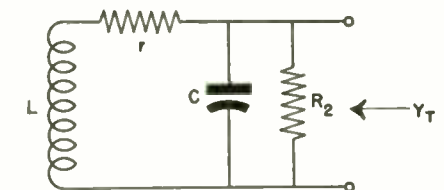

$$G = \frac{\frac{L^2}{\rho \omega C^2} + \frac{\omega^2 L^2}{\rho \omega^2 C^2} \cdot \frac{1}{Q_1^2} + \frac{L}{\rho \omega^2 C^2 Q_1}}{\frac{L^2}{\rho^2 \omega^2 C^2} + \frac{L^2}{\rho^2 \omega^2 C^2 Q_1^2}}$$

use $\rho^2 \omega^2 C^2 Q_1^2$ as common denominator

$$G = \frac{L^2 \rho \omega^2 C Q_1^2 + \rho \omega^2 L^2 C + L Q_1}{Q_1^2 \omega L^2 + \omega L^2}$$

$$R = \frac{1}{G} = \frac{\omega L (Q_1^2 + 1)}{\omega^2 L \rho C Q_1^2 + \rho \omega^2 L C + Q_1} \dots (2)$$

$$Q = \frac{R}{X} = \frac{(Q_1^2 + 1) \omega L}{\omega^2 L \rho C Q_1^2 + \rho \omega^2 L C + Q_1} \cdot \frac{1}{\omega L}$$

$$Q = \frac{(Q_1^2 + 1)}{\omega^2 L \rho C Q_1^2 + \rho \omega^2 L C + Q_1} \dots (3)$$

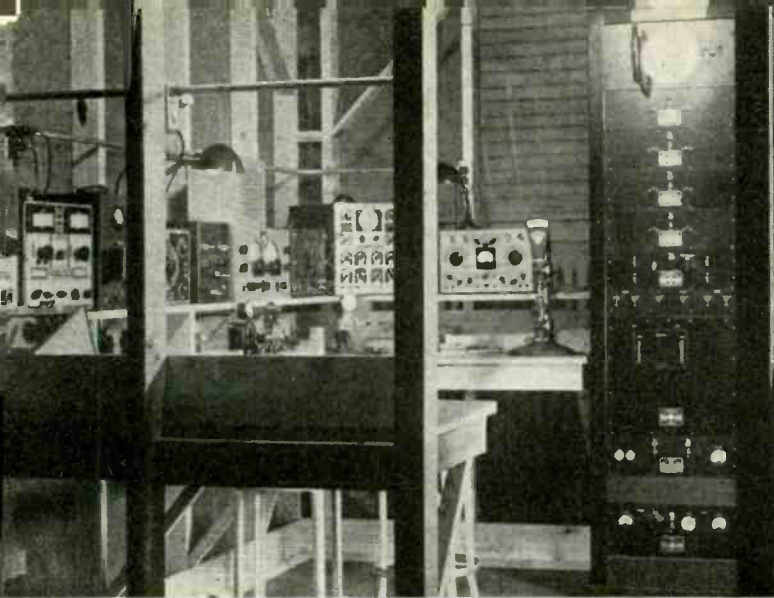

(James Knights Co. photo)

Typical quartz crystal plant test lab, with frequency standard



(James Knights Co. photo)

Typical mounting and testing department

MODERN QUARTZ

RICHARD E. NEBEL

PART 2

IT IS GENERALLY KNOWN that different crystal cuts are oriented to a definite angle with respect to the optic axis. This angle is either positive or negative and cannot be both. It is obvious that the raw crystal must be placed in a certain position before this orientation is made if it is to be correct. Upon examination of a group of typical crystals it may be found that their structures will vary, one being a mirror image of the others, that is, its natural apex faces may appear in reverse when compared to the others. This difference is designated by the terms "right-hand" and "left-hand" quartz. The handedness of the quartz indicates which direction of revolution from the optic axis must be employed, plus or minus. If the natural faces are in evidence the handedness may be de-

termined upon examination. If there are no natural faces evident the handedness is found by use of an instrument that indicates the polarity of the electric charge generated when the piece is subjected to compression.

Twinning

Naturally occurring intergrowth of two or more crystals with their axes or handedness in opposition to each other results in twinning. There are two general types of twinning occurring in quartz known as electrical and optical. Electrical twinning is the result of an intergrowth of two crystals of the same handedness but with the electrical (*X*) axis of each reversed to each other. Optical twins are caused by intergrowth of left-hand and right-hand quartz.

In examination of raw quartz it has already been shown that optical twinning cannot be detected by use of the quartz Inspectoscope. Electrical twinning cannot be observed by this method and requires a different technique. The method is as follows:

The wafers or blanks are cut and then etched for quite a few hours in an acid bath, such as hydrofluoric. The several faces of each quartz molecule are attacked at a different rate by the acid and the result is a set of uniform etch-pits on the surface of the quartz.

If the bar method of cutting is employed the whole bar is etched and in some cases it is possible to cut the bar in two on the twin boundary thus greatly reducing waste.

After etching, the quartz is examined in a Reflection Twinoscope. This instrument consists of a spotlight focussed upon the etched surface and a viewing system set at a certain angle depending upon the cut. The twinned portions are observed as different patterns on the surface of the quartz and the boundaries are marked with pencil. This instrument is also used for detecting optical twins as well as electrical, the two being distinguished by their characteristic patterns.

Orientation

When cementing quartz blocks on the glass plates for mounting on the saw table it is important to know the direction of the *X* axis, otherwise the cut may be made at the opposite angle with respect to the *Z* axis; that is, plus instead of minus or vice versa. The correct mounting position may be determined by use of a pinhole box. This consists of a box containing a lamp and in the top is a number of very small pin holes in a straight line. A hinged ruling device is fastened to the back. An etched *X* block is placed over the pin



(Crystal Research Laboratories photo)

Automatic heat run cycle testing equipment

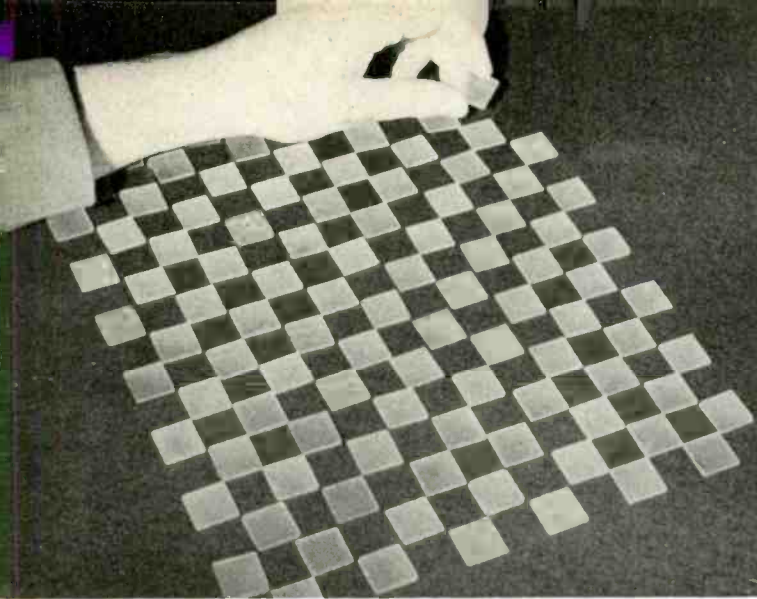

(General Electric Co. photo)

Finished crystals ready for mounting in holders



(North American Philips photo)

Typical final finishing department

CRYSTAL PRODUCTION

Mass production of quartz oscillator plates, ground to highly precise frequency limits, is made possible by improved manufacturing and test methods. These are discussed in this article

holes and depending upon which end of the *X* axis is up, (+ or -) a parallelogram or two horizontal arrows will be revealed. By marking all blocks on one side when the parallelogram is revealed with uniform slope of the outline, errors are eliminated when orienting the saw table. Coordination is also provided with the X-ray goniometer.

An instrument used extensively for mounting quartz on glass plates for sawing is the quartz Mounting Stauroscope. This instrument permits fast and accurate determination of the *Z* and *X* axes. Light from a lamp is projected through a diffusing screen, green filter, polaroid section, quartz, split-field polaroid and reflected by a mirror to the eye-piece. When a piece of quartz is placed on the stage and revolved, positions of extinction or blackout will occur every 90°. These blackout positions occur when the *Z* and *X* axes are parallel to the planes of polarization of the polaroid discs. As here is no differentiation between *Z* and *X*, one must be determined by other means. *Z* is usually distinguishable from the geometric shape or the prism striations in the case of a whole raw crystal or *X* may be determined by means of one of the previously outlined methods in the case of a block.

The Angular-View Stauroscope is

another important adjunct in the quartz crystal plant. It is used to determine the *X* direction in wafers so they may be diced correctly and the *Z* and *X* direction in wafers and blanks so they may be properly mounted on the X-ray goniometer for determination of the angle of cut. Knowing the direction of the *X* axis in a crystal blank is also important at the finishing position where the art method is employed. The principle of operation of the Angular-View Stauroscope is quite similar to that of the Mounting Stauroscope except that the viewing system is set at a fixed angle to the projected light rays.

Detailed Operations

There are many minor yet important operations that must be performed in the crystal plant. It would be difficult to describe all of them due to the many different methods that are employed by the different companies to accomplish the same result. An attempt will be made to outline a few of the in-between steps necessary to carry out all the operations described heretofore.

Quartz is usually mounted on a thick piece of plate glass which is fastened to the saw table by means of clamps. One edge of the glass plate is ground smooth and straight and is referred to as the

reference edge. The saw table, goniometer and mounting Stauroscope are all equipped with a reference bar against which the reference edge of the glass plate is set flush, thus serving to coordinate measurements and angles between the several machines.

The quartz is mounted on the glass plate by means of thermoplastic cement. A small quantity of the cement is spread on the mounting surface of the glass and allowed to become sticky, which takes about five or ten minutes. The quartz is then put in place with the plate on the stage of the Stauroscope. The quartz is moved to the correct position as shown by the stauroscope and then the glass plate is carefully removed from the stage of the instrument. Care must be exercised not to move the



(North American Philips photo)

X-ray irradiation unit. Holder for crystal units is located in front

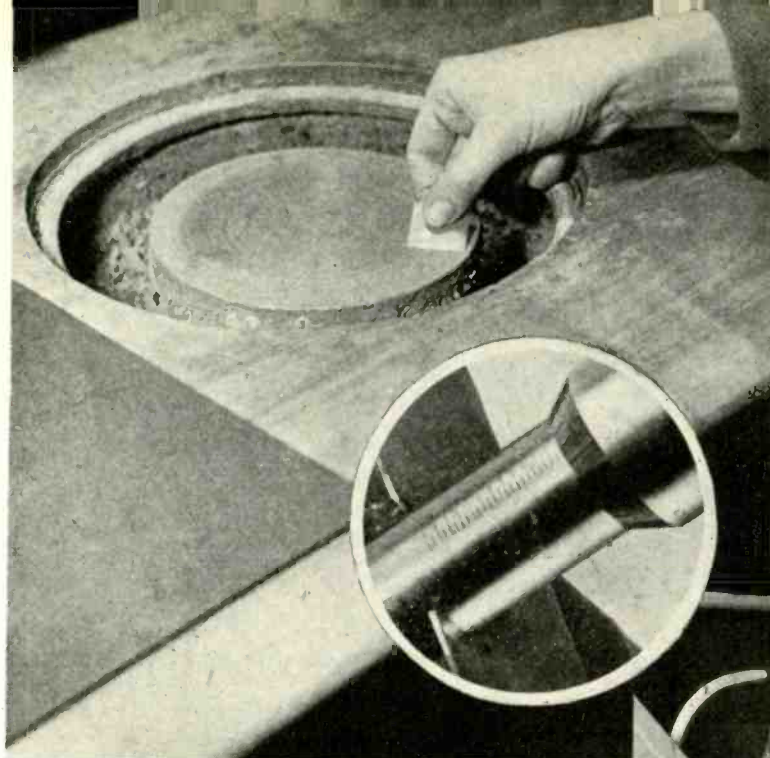

(R. E. Nebel Lab. photo)

(Above) Fig. 1. Edges being beveled on a power-driven iron lap

(Volkel Bros. Machine Works photo)

Diamond wheel edging machine with micrometer adjustments for truing X edge to parallelism with X axis. Insert above is enlarged section of micrometer

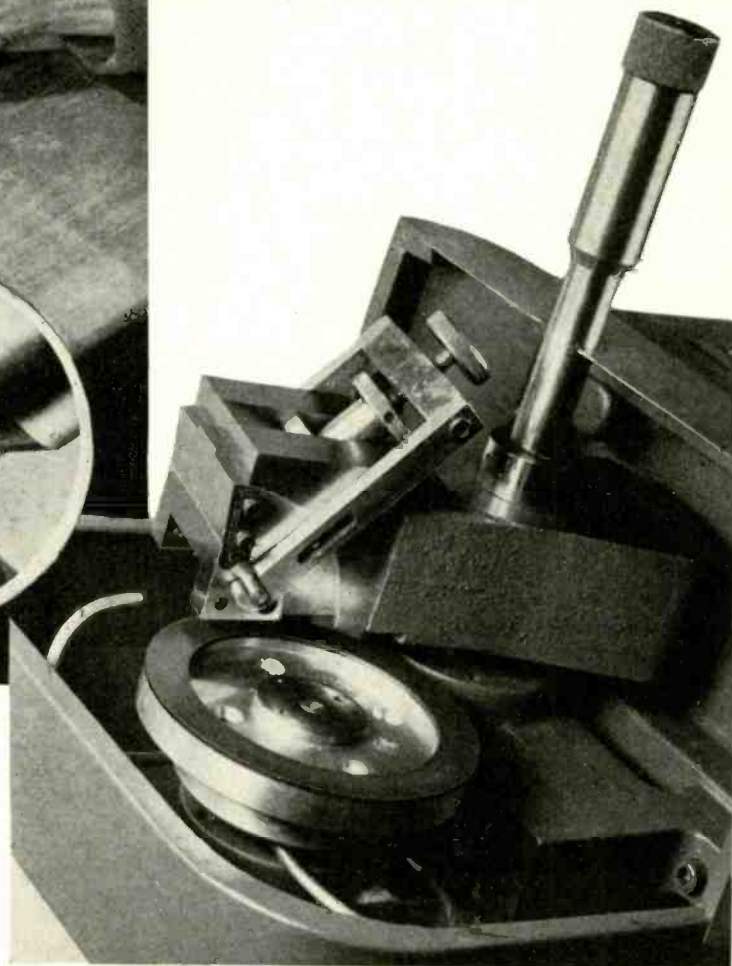

quartz on the glass. Heat is then applied to set the cement. An oven may be used, or else a bank of infra-red lamps. The entire procedure takes a few hours to accomplish. The overall operation is not as lengthy as it seems, however, as a large number of pieces may be baked at a time.

When examining quartz in the In-spectroscope the immersion oil must have a refractive index as close to that of quartz as possible. This is attained by mixtures of various oils in proper proportions. Immersion in oil makes the raw crystal quite transparent and the powerful arc beam then reveals any flaws that may be present.

In connection with the quartz saws it is necessary to use a coolant which must be continuously applied at the point of cut. This is accomplished by means of a pump which may serve a whole bank of saws. The coolant drains off, is filtered, and returns to the pump. Various manufacturers have their "pet" coolants, one being just about as efficient as another. Kerosene may be used and affords high cutting speed but has disadvantages such as being highly inflammable, odoriferous and irritating to the skin of the operator who must come in contact with it. Various mineral oil compounds may be used but do not permit high cutting speeds.

Finishing Methods

All the previously outlined operations must be carried out with great care and accuracy in order to provide the finishing department with perfect blanks. It is this department, however, that engages in the most tedious part of the manufacturing process and requires more skilled personnel than any other.

Reference has been made to the "art" method of finishing. Until recently this was the only method employed. It is still used extensively but in many instances it has been replaced by etching and predimensioning techniques as required by Signal Corps Specifications. Each of the aforementioned terms will be defined in detail.

The art method comprises finishing each crystal by hand, individually, to the required frequency. It is obvious that a great deal of skill and experience is necessary on the part of the finisher in order to accomplish this end efficiently.

A typical finishing position consists of an activity test oscillator, another oscillator containing a standard crystal (these two oscillators are usually contained in the same unit), an interpolation intermediary such as a communication receiver, an electronic frequency meter (cycle counter), a source of run-

ning water, a glass or metal hand lap, a micrometer, and various other components including a means for beveling the blanks.

At the start of the operation the finisher is given a crystal oscillating at the exact frequency required for that particular production run. This crystal is inserted in the standard oscillator and operates continuously throughout the working period. It is tuned in on the receiver, the object being to zero-beat with it the crystal being finished. A supply of blanks is furnished at a frequency lower than the finish frequency. The amount of grinding required depends upon how close the blanks are to the finish frequency. If they are within ten kilocycles or less an audible beat note will be heard in the receiver, which must be in a non-oscillating condition so the unfinished crystal will beat directly against the standard. If the cycle counter is used it will indicate directly the frequency difference. In this case indications up to fifty kilocycles may be had.

The blanks are just as they come from the final lapping operation and the sharp square edges must be slightly beveled. This is accomplished on a small power driven iron lap next to the finishing position (Fig. 1) or by use of a small revolving metal cylinder, the in-

ner surface of which is covered with a diamond impregnated material. An alternative method is the use of a small abrasive block, such as a carborundum stone, on which the blank is beveled by hand. In some cases the edging is done exclusively by another worker.

The crystal is inserted in the activity test oscillator between its electrodes which are selected in advance. The minimum activity reading is given the finisher and the activity of each finished crystal cannot be below this value. The value itself is selected by correlation with the equipment in which the crystal is to be used. Many factors combine to set this value which is specified by the purchasing agency, such as the Signal Corps. If the crystal oscillates, its frequency is noted or, more precisely, the distance it has to be moved to reach the finish frequency. It is then ground on the hand lap, washed, dried and tested again for frequency. Activity at this point is not of too much importance. It is only necessary that the crystal oscillate in order to know how much it has to be moved after each lapping operation. The dimensions of the crystal in relation to each other have a direct bearing upon the activity. Edge grinding changes the dimensions and therefore may be resorted to if it becomes necessary to raise the activity. At times during the lapping operation the crystal may stop oscillating altogether. It is then necessary to edge grind a bit to start oscillation.

In order to assure that maximum activity will be attainable the crystal must be kept extremely flat and parallel. It is here that finishing skill asserts itself. If a blank is out of true no amount of edge grinding will raise the activity.

After the blank has been brought to within a few hundred cycles of the finish frequency, attention must be given to the activity. Edge grinding is employed to bring it up to minimum value or higher. Edge grinding by hand is an uncertain process and is employed on a hit-or-miss basis, i. e., if the activity is not satisfactory it is continued until the activity meets requirements. The reason

for stopping surface grinding when the frequency is still a bit low is that edge grinding sometimes varies the frequency slightly and if brought right up to frequency the crystal might be over-shot while working on activity. If the frequency is still low after activity is satisfactory a touch to the lapping plate will bring it up with negligible effect on activity. Such is the operation referred to as art finishing. The implication is obvious.

Predimensioning

As mentioned previously, the dimensions of the crystal affect the activity. The dimensions also affect the temperature-frequency characteristic of the crystal. The reasons for this phenomenon are as follows. A quartz crystal is capable of oscillating at more than one frequency, that is, in modes other than that mode employed in determining its basic frequency. The fundamental frequency is determined by the thickness dimension in the case of communication frequency crystals, the type in which we are interested at the moment. Other frequencies, determined by the width and length respectively, will also be generated and as these dimensions are much

greater than the thickness these extraneous frequencies will be very low. Harmonics of these low frequencies will interfere with the useful thickness dimension frequency. As pointed out earlier, the crystal may stop oscillating together at a certain stage of the face grinding. This is due to interference from these spurious modes and is corrected by edge grinding which, in effect, move the interfering harmonic away from the fundamental frequency. The exact relationship between the length and width dimensions and the thickness dimension in order to avoid this harmonic interference can be computed mathematically. Thus, for a given frequency optimum dimensions for length and width can be given and when these two dimensions are held within close limits the need for edge grinding in the finishing operation is eliminated. This procedure is known as predimensioning, that is, the blanks are ground to the proper dimensions before reaching the finishing operator.

Very close tolerances are required for this method to be successful and special edging machinery is required. Control within less than one-thousandth of an inch is necessary.

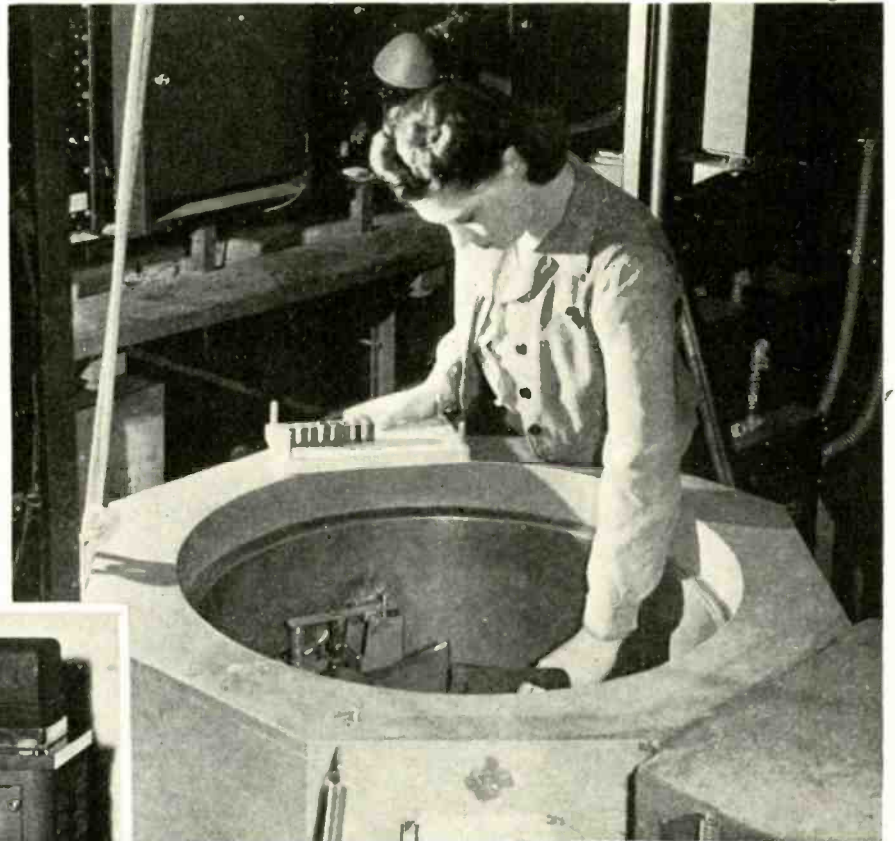

(RCA-Victor photo)

Temperature test chamber. Note group of crystals plugged in work holder

(Left) Fig. 2. Hermetic seal test equipment.

(North American Philips photo)

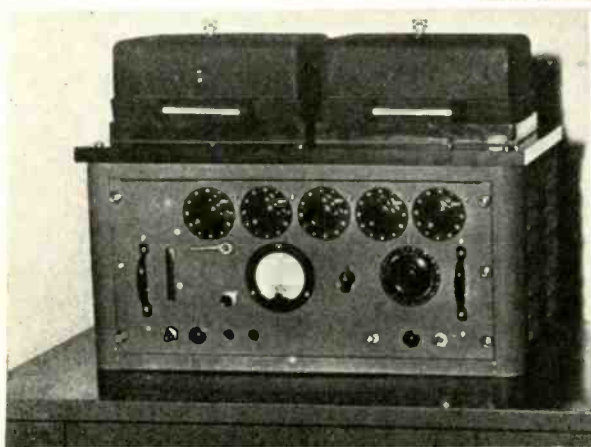

Etching to Frequency

A shocking discovery was made some time ago when crystals were taken from Signal Corps storage where they had been for more than a year. It was found that the frequency of all had increased as much as two kilocycles above that marked on the holder! This effect, called ageing, had been known for many years but its extent had never been proven. Examination disclosed a microscopic white powder on each crystal and it was finally concluded that this represented disintegration of quartz on the surface, thus raising the frequency. It was also learned that this was directly due to cracks and strains set up on the surfaces by the abrasive with which the crystals were ground.

Previous use of acid had been made in etching crystals to frequency but the method was never very popular due to the hazards connected with the use of acid. However, etching was turned to experimentally to determine if the problem of disintegration could be solved. It was!

Blanks are etched in an acid solution to a point very close to the finish frequency. Specifications require that a minimum amount of quartz be removed by etching in order completely to eliminate ageing by removing the abraded portion of quartz on the surface. The blanks are then sorted into groups of the same frequency and are etched again in a finishing solution to final frequency. Most of the hazards of acid are eliminated by use of ammonium difluoride solutions which are used extensively. By thermostatically controlling the temperature and the strength of the finishing solution, the finishing operation is based on time, the rate of frequency change thus being closely controlled. It will be noted that the skill required for art finishing is not necessary when etching is employed. Machines have been developed in which groups of crystals at a time are etched in successive steps, automatically.

Other finishing methods have been developed with varying degrees of success. The tumbling method placed a large number of blanks in a glass jar filled with various combinations of abrasives and agents. The jar revolved at a slow speed and the tumbling action removed quartz from the blanks evenly. Large numbers of blanks were ground at a time, the jars being driven in banks so the process was not too slow even though it took hours to remove a few kilocycles.

Another interesting application of X-rays is found in the X-ray irradiating technique. It was found that by exposing a finished quartz crystal to a beam of X-rays the frequency was *lowered!* This has made possible the retrieving of many crystal blanks that had been over-shot in the initial finishing operation. The amount the frequency can be lowered is finite and depends upon the frequency of the crystal. This operation can be controlled very closely on a time basis just as in etching.

Cleaning, Mounting and Testing

Crystals must be scrupulously clean before mounting in holders. The cleaning procedure varies more between respective companies than any other phase of the manufacturing procedure. Various cleansers are used, the crystals are scrubbed with a small brush, rinsed in clean water and mounted in the holders between their electrodes. One mounting method is to tighten the covers only halfway and then bake in an oven. This evaporates any moisture that may have accumulated in the assembly. The covers are fully tightened while the units are still hot. When using holders in which the pins are not molded in, a waterproofing substance such as Glyptol is painted around the base of the pins and on any joint that might admit moisture.

Many methods of marking holders are used such as stamping on metal cover plates, printing with metallic ink



(North American Philips photo)

Double quartz crystal intergrowth viewed between crossed polarizers in oil bath. Camera line-of-sight is about parallel to optic axis of upper crystal. Optical twinning permeates this crystal pair

and hot-stamping directly on the plastic.

Contract specifications call for crystals that will not vary in frequency beyond certain limits and activity that will not drop below a certain value when the crystal unit is subjected to a change of temperature between sub-zero and very high values. As a test of this kind consumes a great deal of time it was necessary to develop means of putting large quantities of crystals at a time through this so-called temperature run. Automatic machines make recordings of frequencies and activity readings of each individual crystal in a group at small time intervals while the temperature is slowly varied from one extreme to the other. Inspection of the chart then permits rejecting those units that fail.

All crystal holders must be sealed against moisture. Synthetic rubber gaskets such as Neoprene are used under the covers for this purpose. A Hermetic Seal Testing machine as illustrated in Fig. 2 is used to determine the efficiency of the seal.

Crystal units are subjected to other tests before they are passed for acceptance by the prime contractor. The drop test consists of holding the unit a certain distance above a block of hard wood and dropping it from different positions. The activity and frequency must not have varied after this test.

Another test is that of vibration. A group of crystals are put in a vibration machine and subjected to a certain amplitude of vibration for a period of time. The crystal characteristics must remain unchanged to be acceptable.

It is hoped that the reader has gleaned a general picture of quartz crystal manufacture. This picture can be viewed only from a distance, however, as a detailed account of each individual phase of operations would comprise a technical paper in itself.

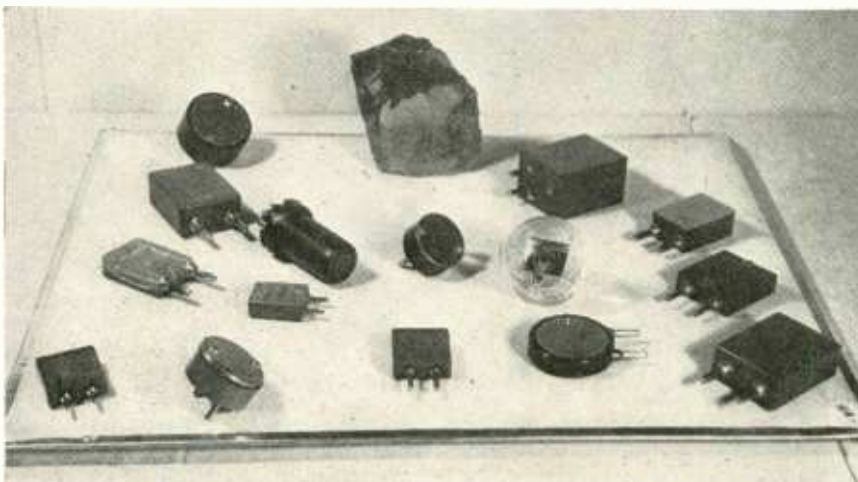

Group of mounted crystals. Block of raw quartz in rear.

(R. E. Nebel Lab. photo)

Recent Trends in Precision Resistor Design

A. P. HOWARD

A review and description of precision wire-wound components suitable for current radio and electronic apparatus

RADIO DESIGNERS who use accurate resistors have cause to review their opinions of precision resistor performance and design. Credit is due to the more recent advanced thinking of the manufacturers of such resistors.

Early accurate resistors were primarily laboratory units for laboratory use. They were designed to be treated with "kid gloves"; they were not fully suitable for radio and electronic use. As a result, radio manufacturers did not make full use of the capabilities of these resistors.

With the introduction of delicate test equipment, stabilized power supplies and the like for military production, the manufacturer had to "lick" this problem.

Prewar Resistors

Precision resistors were once fundamentally simply a roll of enameled resistance alloy wire wound on a spool or bobbin. The wire was cut at the point where the resistance value was within the tolerance required. These parts, the wire and the spool, determined the performance and life of a typical precision resistor. A typical precision resistor, cross-sectioned, is shown in Fig. 1, illustrating the various parts of the unit.

Occasionally, too, the resistor was wax dipped. The process was not completed to dry out surface moisture or to age the resistor, but merely to hold the resistor together.

The wire employed was a resistance wire selected for its temperature coefficient and high resistivity. The wire was pre-coated with a conventional oil base enamel to certain standard dimensions.

Coil form materials included a variety of insulating materials: pressed paper,

lava, machined laminated phenolic, porcelain, steatite, etc.

Each part had its limitations. These part limitations set the maximum quality level of accurate resistors. Remember, however, that these resistors were never intended for a service more rigorous than the laboratory.

The basic faults can be divided into several classes: overload, humidity, high temperature operation, aging, mechanical weakness. Each of these classes will be discussed in detail below where we will consider the fault and the industry-applied correction.

Overload Failures

Failures due to overload are difficult to ascertain because so many other factors enter into the life of the resistor. Let us, therefore, define overload as an overvoltage condition which can cause eventual failure of the resistor.

Two effects manifest themselves: increased power dissipation and the approach to the ultimate dielectric strength of the wire. (This statement overlooks purposely the temperature limitations of the bobbin material and the coating medium employed.)

What overload does to a precision resistor is the subject of Fig. 2. Here, heating of the resistor occurs with overload conditioning; here, heating of the resistor causes resistance changes. Testing was conducted by applying various fractions of the rated load to the resistor at ambient temperature. Fig. 2a shows the net temperature rise due to rated load. Part of the non-linearity of the curve is due to the relatively poor thermal conductivity of the resistor enclosure. Fig. 2b shows the resistance change with increased load. Voltage coefficient, *per se*, can be discounted as a factor in the resistance change of a

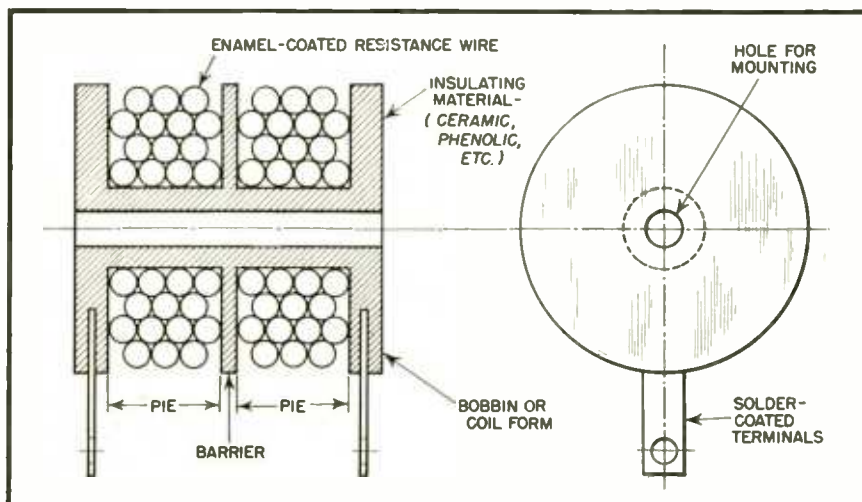

Fig. 1. Typical accurate resistor construction. The direction of winding each pie is reversed to minimize self-inductance

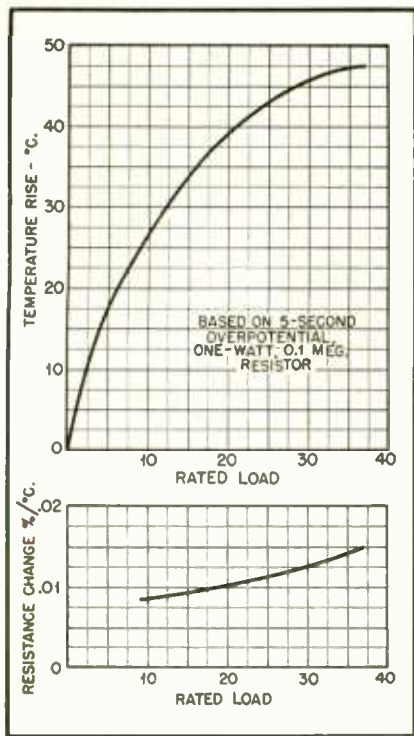

Fig. 2. In (a) above, temperature rise is shown for various rated loads. Below (b) shows percent resistance change under same conditions

wire-wound resistor. It will be noted, then, that the resistance change with increased applied load is not linear with the increased hot spot temperature. This change can be attributed to certain things:—the resistor's associated terminals, etc., changing resistance, and the differential temperature between the internal hot spot and the surface hot spot. This subject will be pursued further under high temperature operation.

Such heating as has been discussed causes several effects: heating of the wire insulation and heating of the impregnating, coating, or enclosing compound. Since the dielectric strength of most wire insulation is inversely proportional to the maximum continuous operating temperature, any heating due to overload will cause the resistor to approach its point of ultimate failure.

At the same time, the very cause of heating, i.e., the voltage applied, causes a higher stress level on the wire insulation. These twin effects resulting from the same cause are determining factors of resistor performance and life.

In certain accurate resistor designs these effects caused greater damage than in others. Most vulnerable point in these designs is the so-called cross-over point. This cross-over point in the resistor bobbin is where the resistance wire must be bridged from one pie to the next. (Each segment of a bobbin resistor is called a pie.)

The cross-over point is critical for several reasons. Here the last turns of wire of the first pie (on the top layer of the first pie) must be brought through

or over the barrier isolating the pies into the second pie to form the bottom layer. If the bobbin and winding techniques separate the first turn of the first pie and the last turn of the first pie, no great damage will result.

Several constructions are illustrated in Fig. 3. Note that Fig. 3a illustrates the last turn of pie one contiguous with the first turn of pie one. Assuming a 300-volt potential exists across the two-pie resistor, the working potential of the first and last turns of pie one is 150 volts. This means, of course, that this section is stressed far more than any other section of the resistor, contributing to its eventual failure at that point.

The other illustrations in Fig. 3 show industry-applied corrections. Design of the slot to slant the wire is shown in Fig. 3b; insulating the wire at the point of cross-over by a wrap or tube of insulation is shown in Fig. 3c; proper impregnation technique utilizing the dielectric properties of the impregnating compound is illustrated in Fig. 3d. Examination of other precision resistors will prove that these are but few of the commercial techniques used to alleviate this condition.

Overvoltage Conditions

Thus far, we have considered overvoltage conditions only as applied to the cross-over point. Although this is the most dangerous point if proper design is not completed, we have shown that careful analysis on the resistor designer's part can "lick" this problem.

But we have not struck at the root of the problem if we confine ourselves only to cross-over points. The resistance wire must be insulated and it is this insulation which determines the resistor's performance.

Until slightly before the war, only two resistance wire insulations were available: oxide coating and conventional baked enamel coating. Little use was made of oxide coated wire because of the non-uniformity of the alloy oxide coating. (This coating is really a formation of the oxides of the resistance alloys on the surface of the wire. This type of insulation has been used commercially in power wire-wound resistors but its use has been largely discontinued because of the condition mentioned.)

The use of baked enamel-insulated wire has been continued even during the war period for it represents a satisfactory insulation, if properly controlled. Tighter control of the enamel has been necessary to meet the requirements of the precision resistor manufacturers. At first glance it would seem that, by baked enamel-coated (copper) wire standards, this insulation should be satisfactory.

But two discrepancies occur in this

line of thinking, (a) Magnet wire coils are not usually used at a point near the ultimate dielectric strength of the wire insulation and (b) the coating bare annealed copper is an industry with far more experience. Coating annealed alloys of nickel, chromium, iron, etc. introduced new problems of adherence, flexibility, thickness control, baking temperatures, and the like.

As a result the resistor industry and the wire industry have patiently improved the quality of the enamel coating, but still mediocre wire is being produced because such a huge quantity was required for wartime uses.

Three new insulations have appeared which are promising: polyvinyl acetal or synthetic enamel coated wire, ceramic-insulated wire, and silicone insulated wire.

Synthetic enamel has some outstanding properties to recommend it. Outstanding property is high dielectric strength per unit thickness. Increased uniformity of coating has resulted, or perhaps the individual pin-hole flaw in the insulation is not as large as that of conventional enamel. Its outstanding weakness is its low temperature of high temperature deformation. Manufacturing techniques can be suitably arranged to account for this, but the upper operating temperature is severely restricted.

Limited information is available on the other types listed above. Both possess better high temperature properties and good dielectric properties.

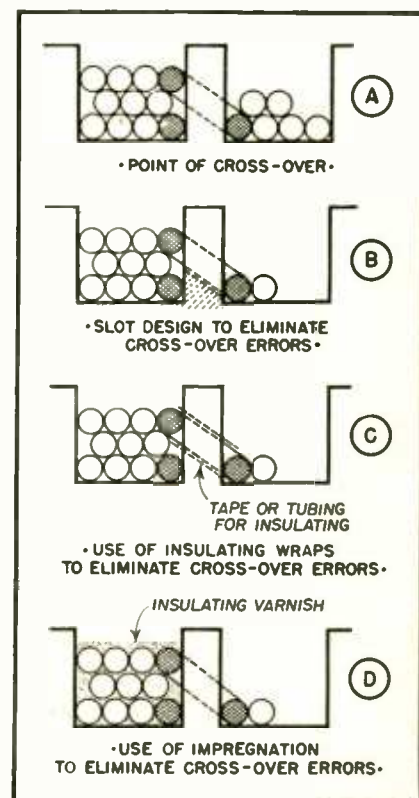

Fig. 3. In (a), cross-over point is shown. Improved methods to avoid breakdown shown in (b), (c), and (d)

Certain other design devices to prevent overload or overvoltage breakdown will be discussed in succeeding sections.

Humidity Failures

Humidity failures can be defined in terms of four fundamental parts of the accurate resistor; resistance wire, enclosure or coating, bobbin form, termination.

The resistance wire is again of importance because its behavior under corrosive atmospheres determines its life. Certain alloys have been used in the past which have been undesirable from this viewpoint. The explanation for the use of these alloys is easy:

The price of a precision resistor of a certain tolerance can almost be equated to a constant of the bobbin price plus a new constant times the price of the resistance alloy. Thus, the differential price is almost determined by the ohms per circular mil foot. This resistivity value determines the amount of wire required and (together with the tolerance) almost predicts the spoilage ratio. Thus, when higher resistivities are employed, the price is lower.

Because of this price factor, certain alloys have been developed bearing a high iron content. These alloys lend themselves to high resistance in a small space at a lower cost.

However, these alloys have not contributed to the improvement of the accurate resistor for they have been corrosive. As a result, more and more, resistor manufacturers have shied away from these alloys till now these alloys are used only on special order and without risk to the resistor manufacturer.

Certain alloys have been found extremely good under corrosive conditions, but these alloys have usually set a maximum limit of 675 ohms per circular mil foot nominal on the manufacturer. The alloys most commonly used are the subject of Table 1; resistivity and temperature coefficient are included for ease of identification since all are known not by their chemical composition but by a proprietary brand name. The absence of an alloy from this list does not imply its unsuitability for precision resistors but merely its confined use. Criterion for resistance wire should be the iron content. (It is the writer's considered opinion that any alloy containing over 25% nominal iron composition should not be used for resistor construction, particularly accurate resistor construction. With this statement, some resistor manufacturers may take exception. However, this is a safe estimate.)

Quite another is the problem of proper wire size. It has been almost axiomatic in Armed Forces purchases

TABLE I. RESISTANCE ALLOYS		
COMPOSITION	RESISTIVITY (Ohms/cm ²)	TEMPERATURE COEFFICIENT (%/°C)
NICKEL 60%, CHROMIUM 16%, IRON 24%	675	.022
NICKEL 80%, CHROMIUM 20%	650	.014
COPPER 55%, NICKEL 45%	294	±.002
COPPER 84%, MANGANESE 12%, NICKEL 4% ("Manganin")	290	±.002
COPPER 78%, NICKEL 22%	180	.016

Characteristics of typical alloys used for winding accurate resistors

of resistors to use wire of larger diameter than the minimum considered satisfactory for the trade. For example, the Armed Forces have insisted that 2.5 mil diameter be the minimum wire size in the purchases of power wire-wound resistors; however, the trade in general considers 2.0 mil diameter wire safe.

Likewise, the same conflict occurs in precision resistors. Latest Armed Forces purchase requirements insist on 1.5 mil diameter wire or better. Yet the trade has been using down to 0.8 mil diameter wire. It can be asked, "Is 0.8 mil diameter wire safe?" It is the writer's observation that this size is not safe.

Where to draw the line becomes the problem. Standard sizes of wire follow: (all sizes given in mils diameter) 0.8, 0.9, 1.0, 1.1, 1.2, 1.3, 1.4, 1.5, 1.75, 2.0, 2.25, 2.5, 2.75, 3.1, etc. What the change of wire size does to increase resistance is shown in Fig. 4. The values are calculated on the basis that resistance is inversely proportional to the cross-sectional area of the wire. No attention has been paid to terminals, winding forms, etc., since this is purely theoretical.

In determining the proper size, we have examined the increase of resistance with decreasing wire diameter, but there are these other factors to be considered. Alloys must be drawn to fine gauges for the resistor manufacturer, and coated. These alloys have been properly annealed after the last drawing operation, but must be stressed during any subsequent winding or enameling operation.

At the same time, non-uniform grain structure, setting up micropotential differences between one section of the wire and another section of the same wire, introduces electrolytic corrosion.

It is these two factors, non-stress free wire and non-uniform grain structure, which influence the final choice of wire size. The influence of severe atmospheric conditions of exposure will increase these factors' influence upon the life of the winding; non-severe conditions will permit the use of extremely fine gauges since electrolytic corrosion and aging will be less affluent factors.

Probably enough has been said for

the radio designer to appreciate some of the difficulties which he may run into if the proper resistance alloy and wire size is not selected. Whatever choice is made on wire size may be in error if the designer doesn't fully understand or if he underestimates the problem.

Enclosure or Coating

We have said that the choice of enclosure or coating affects the humidity characteristics. We have also recalled that the primary reason for the wax coating on previous precision resistors was to hold the winding on the form.

What types of coating and enclosing media are currently available, contrasted with the wax coating previously applied? Among the coating materials are high temperature waxes, phenolic and alkyd resin based varnishes and lacquers, silicone varnishes, etc. Enclosing materials include glass and ceramic forms which provide suitable glass- or ceramic-metal seals, metal cases with metal-glass seal terminals, molded and laminated plastic covers, etc.

In discussing the relative advantages of each of these materials (above), there is no intent to describe the product of any individual manufacturer, but to describe in general terms the advantages and disadvantages which accrue from the average run of the materials listed. Special concoctions and the like will produce different results, it is true. At the same time, the methods described may border on patents controlled by precision resistor manufacturers; it is, therefore, only the intent to survey the field.

Before considering individual types of coatings or enclosures, certain fundamental concepts must be established: increased dissipation is possible with a coated resistor; increased protection against high humidities is possible with an enclosed resistor.

Coating a resistor has several basic purposes. One of the most important uses of a coating is to secure a mechanical bond of the resistance wire to the bobbin. Equally important reasons are to remove causes of corrosion, increase the dielectric strength of the wire insulation, and to "age" the resistor. (Considered below under the heading of "re-

sistor aging" is the subject of insulating coatings as a means of aging.)

Almost any wax or varnish coating will give a good mechanical bond between the wire and the form; not all coatings, however, will improve the corrosion resistance and increase the dielectric strength of the resistor. Improvement of the corrosion resistance as the first phenomenon of the coating is based on several conditions, pre-heating, vacuum impregnation, water-solubility of the coating, hardness-flexibility of the coating, baking time and temperatures.

Pre-heating of the resistor is an almost satisfactory substitute for a good vacuum impregnation of the resistor. Either action is required to drive out any trapped moisture prior to coating or impregnation. If moisture is not removed, the trapped content will cause progressive internal corrosion and eventually destroy the resistor.

The time and temperature of baking the applied coating is important to the extent that it insures a permanent seal against moisture. Other considerations of the hardness or flexibility of the coating deal only with the life of the resistor under adverse conditions.

Enclosing a resistor is an easy way of protecting a resistor against adverse conditions if a good hermetical seal can be effected. Among the more recent types of seal, metal-to-metal or ceramic-to-metal seals are recommended. Cer-

tain other enclosing media have been on the market for some time, such as molded or laminated phenolic covers. These enclosures are satisfactory under the same conditions as the average coated resistor, but afford little more protection.

Other Humidity Protections

Two other parts of the resistor affect its performance under high humidity conditions or other corrosive conditions, as we have pointed out. These parts are the bobbin and the termination.

The termination becomes vital because of corrosive fluxes used by some manufacturers to braze the nickel-chromium alloy to the terminal. However, there are proper cleaning methods after the use of corrosive fluxes and there are non-corrosive solders and eutectics which can be used to secure a good mechanical connection of the resistance alloy to the terminal.

Bobbin materials have been known to cause failure of accurate resistors. These failures have occurred because of the moisture pickup of the form. Certain materials have a high porosity: some electrical porcelains and refractory bodies, most laminated phenolics, lava, etc. Superior materials, under high humidity conditions, include steatite, some electrical porcelains, and molded melamine. In addition, these latter forms offer higher arc resistance properties.

High Temperature Operation

It seems that the analysis of an accurate resistor becomes increasingly an analysis of the component materials. So it is with analyzing the high temperature operation of a resistor. There are, however, certain other considerations which must first be faced in dealing with high temperature operation of these resistors.

Consider for a moment the dissipating effort of a resistor. Assuming an equal distribution of resistance wire per pie, the voltage across each section will be the same; the volts per turn of wire will be approximately the same. But the heat on the surface of the resistor can escape more rapidly from the outer surface than from the inner surface. Therefore, at the base of the resistor, at or near the inner diameter of the bobbin, the hottest spot will occur.

This effect has not been measured concretely because of the difficulty of building a representative resistor with thermocouples placed at the significant points. At the same time, this hot spot temperature will vary from resistor to resistor of the same manufacturer with the resistance value.

This intangible problem of correct rating of resistors is thrown in because the problem is one of the most troublesome to be encountered in the life of the resistors. Certainly, we can assume some arbitrary high temperature limit of each material considered for use in the resistor's construction; we can also assume some differential temperature between the measured surface temperature rise and the hottest spot temperature, based on the degree to which the resistor is packed with resistance wire.

Consider the limitations of the resistance wire (for it is the wire insulation which takes the "beating" under high temperature operation). Four types of insulation, as we have already pointed out, are customarily used: polyvinyl acetal, baked oil base enamel, silicone, ceramic. Safe limits of these wires will evoke some disputing statements from the manufacturers of these insulating coatings. It is the writer's personal opinion that the following ratings should be assigned: polyvinyl acetal, 125°C.; oil based enamel, 150°C.; silicone, 200°C.; ceramic, 350°C. These figures are based on either thermal distortion of the wire film or severe lowering of dielectric strength.

Joint Army-Navy Specifications prescribe that wattage ratings shall be based on a 20°C. rise over an 85°C. ambient. It is, therefore, conceivable that polyvinyl acetal insulated resistance wire will be distorted at some point below the full dissipation temperature.

The bobbin form, since it is near the

[Continued on page 79]

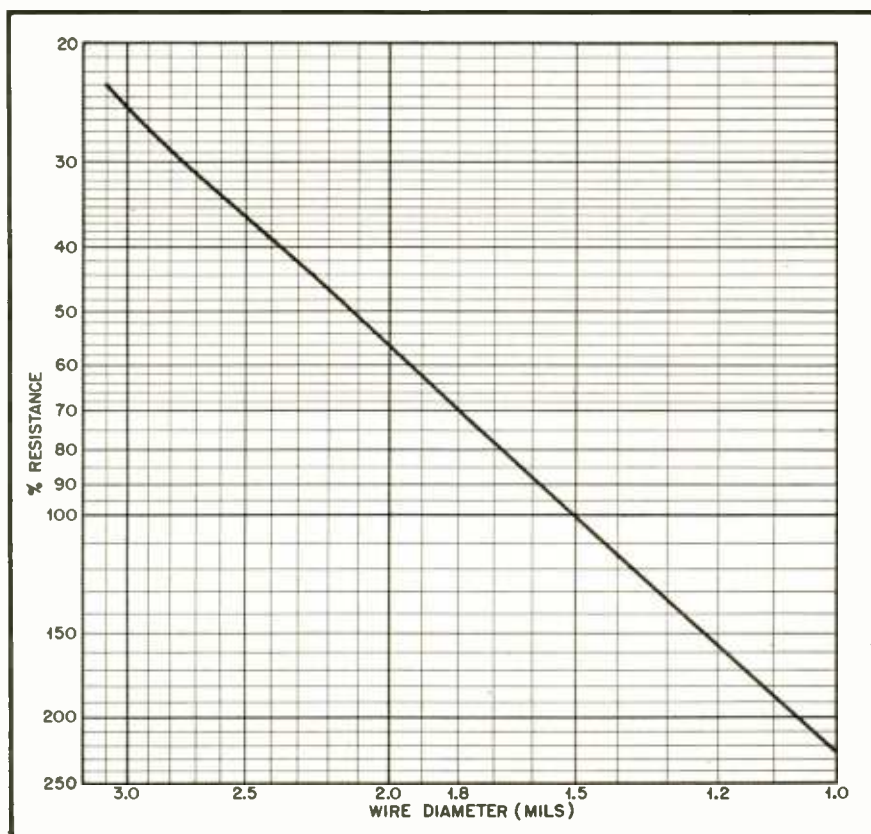

Fig. 4. Graph showing resistance versus wire size

FREQUENCY CONVERSION in Superheterodynes

M. A. CHARLES

An analysis of various methods of obtaining frequency conversion

BASICALLY, frequency conversion in a superheterodyne is a simple problem, but if maximum efficiency is to be obtained the proper type converter must be employed. This article is intended to clarify some of the problems of converter operation as presented by the wide variety of conditions encountered.

A résumé of the desired features are as follows:

1. High conversion gain, with reasonable uniformity on all bands.
2. High oscillator strength of fairly uniform amplitude and stability.
3. Freedom of interaction between oscillator and signal frequency circuits.
4. Low microphonics.
5. Low tube noise.

Each of these items requires considerable study to achieve optimum performance: furthermore, some items such as maximum gain and minimum noise are not mutually consistent. It is up to the designer to evaluate the relative importance of each and compromise accordingly.

Before proceeding further the distinction between a converter and a mixer tube should be thoroughly understood. This can be stated very simply as follows—a converter tube is one in which the actual frequency conversion takes place in a single tube, while a mixer tube requires a separate oscillator tube to perform the same function.

Many types of frequency conversion systems are being used in present-day receivers and the choice of the system to be employed depends on several factors, such as frequency range, stability requirements, signal strength available, and cost.

In general, there are two basic circuit arrangements, (1) signal and oscillator injection on the same element, (2) signal and oscillator injection on different elements. Of these two basic systems the second is probably the most popular, although the first is not without merit. In the case of oscillator and

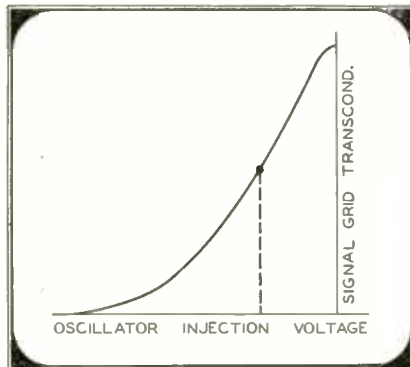

Fig. 1. Operating point on signal grid transconductance characteristic for frequency conversion

signal injection on the same element we find crystals, diodes, triodes and pentodes being used as converters or mixers. Where the signal and oscillator voltages are applied to different elements in the frequency converter or mixer, obviously only multi-element tubes are used.

Conversion Transconductance

In the study of converter systems we are concerned with conversion transconductance of a tube instead of the ordinary mutual conductance, or control grid-to-plate transconductance. This is the ratio of an increment of current in the i-f transformer primary to the increment of signal voltage required to produce it. Knowing the conversion conductance the gain can be calculated by the equation,

$$\text{Converter gain} = \frac{S_o r_p Z_L}{r_p + Z_L}$$

where S_o is the conversion transconductance, r_p is the plate resistance of the tube and Z_L the output load impedance (i-f transformer).

The sum or difference (signal plus oscillator or signal minus oscillator) frequency may be used, since the amplitudes of each are equal in the converter plate circuit. It is customary to use the difference frequency because of greater possible amplification at the lower frequency. The oscillator frequency may be

above or below the signal frequency with little or no difference (in most cases) in the conversion gain. The optimum point of operation is determined by the oscillator voltage injection vs. converter transconductance curve and usually results in the peak oscillator voltage being approximately equal to a voltage midway up the slope of the curve. See Fig. 1. The conversion transconductance of most tubes is approximately equal to 28% of the maximum zero bias transconductance when operated with the oscillator at its fundamental frequency.³ This is reduced to about 14% of maximum if the second harmonic of the oscillator is used.

For wide frequency coverage a separate oscillator tube is recommended because of the difficulty in obtaining the desired characteristic in a combination tube. This also permits the choice of a wide variety of injection circuits since mixing can be accomplished in several ways, such as, in series with or inductively or capacitively coupled to the signal or other grids. In the case of converter tubes with built-in oscillator sections, the oscillator voltage often is present on more than one element and unless the phase relationship of the two injection voltages is correct this often results in partial cancellation or demodulation effects. In general, then, it can be said that mixer tubes with a separate oscillator are usable at higher frequencies than converter tubes with built-in oscillator sections.

Square Law Operation

The frequency converter stage of a superheterodyne for low, medium and medium high frequency ranges is usually operated as a square-law device. The reason for choosing this type of operation can be explained by referring to Fig. 2A, where a weak signal modulated 50% is shown operating at point A on the linear characteristic to produce the output signal X. Now suppose the signal amplitude increased (modulation remaining 50%) so that the device op-

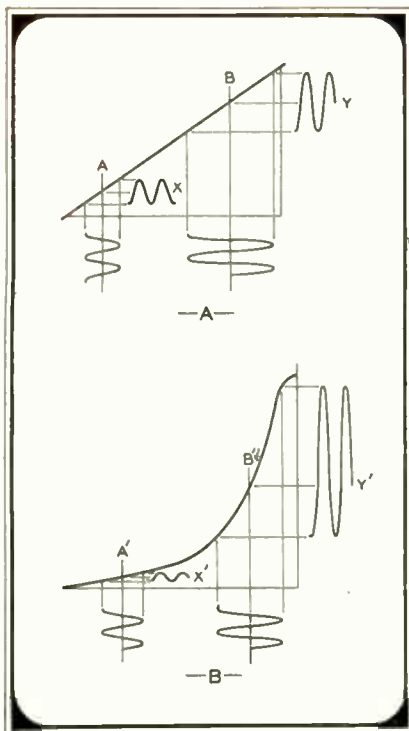

Fig. 2. Comparison of linear and square-law operation for frequency comparison

erated at point *B*. This would produce an output signal *Y* which is greater than the output signal *X* by the same proportion that the signal was increased. In other words, the output signal amplitude is directly proportional to the input signal.

Considering the square-law characteristic (Fig. 2*B*) and assuming the same weak signal operating at *A'* produces the output signal *X'*. When the signal amplitude is increased as before, the device operates at point *B'* but the output signal is now several times that obtained with linear operation. This is due to the higher transconductance at point *B'* under square-law conditions. It would appear then that such a characteristic might accentuate any fading of the signal, and this would be true if it were not for the presence of the local heterodyne oscillator which establishes operation at a favorable point on the curve. For this reason square-law operation is no more subject to fading than linear operation provided the voltage injected by the oscillator is constant. It is also evident from the diagram that the amplitude of the oscillator voltage should be sufficient to permit operating at a favorable point on the characteristic curve.

The effect of various oscillator injection voltages is shown in Fig. 3 and this clearly indicates the desirability of using an oscillator whose amplitude will permit operation at a point on the characteristic where the slope is the greatest (highest gain). This more or less establishes the amplitude of the oscillator, but when the oscillator and signal are

injected on the same tube element the sum of the two must never drive the mixer grid positive. The curve also indicates that the oscillator injection voltage should be uniform over its tuning range, otherwise the amplification will vary throughout the band.

From the above it can be seen that square-law operation of the mixer is to be preferred since with a linear characteristic the i-f produced would be a function of the signal input, while with square-law operation some gain is obtained. (UHF mixers are an exception, as will be explained later).

Triodes

In a triode mixer the oscillator is injected on the cathode or grid, either inductively or capacitively. The mixer may be operated with the oscillator at its fundamental or at a harmonic, but in the latter case a stronger oscillator will be required and this may present some difficulties.

When both the signal and oscillator voltages are injected on the same element the signal-to-noise ratio is excellent. However, unless special precautions are taken severe interaction between the signal and oscillator circuits will be present. When using triodes input circuit loading becomes appreciable at high frequencies due to feedback through the grid-plate capacity of the tube. This is particularly important when there is an appreciable capacitive reactance (at the signal frequency) in the plate circuit of the mixer. Since high frequency operation usually dictates the use of a high i.f., it is evident that a compromise between gain in the i-f transformer and input loading of the signal circuit must be made. Input loading effects can also be reduced by using a relatively high oscillator injection voltage if grid leak bias is employed. This will bias the tube near cut-off so the cathode current only flows during a small part of the cycle and the loading is only effective during part of each oscillator cycle.

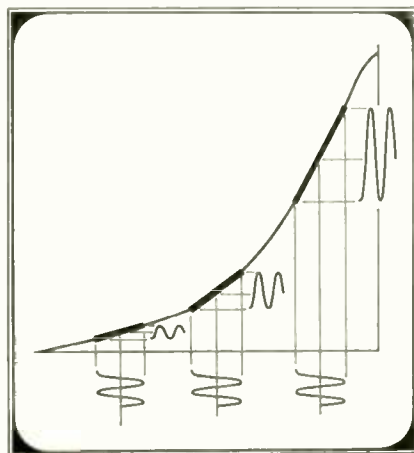

Fig. 3. Mixer efficiency vs. oscillator strength

Transit time and lead inductance effects may be minimized by special high-frequency tube design.

Triodes as mixers are characterized by high conversion transconductance, excellent signal-to-noise ratio and low cost.

Pentodes

Some pentodes make excellent mixers, and although they have a slightly lower signal-to-noise ratio than triodes they are far superior in this respect to tubes of the pentagrid class. The oscillator voltage may be injected on the signal grid, cathode, screen or suppressor, making possible a variety of circuit combinations.

In general, cathode injection is employed since it is comparatively easy to modulate completely the plate current by this method. Both the screen and the suppressor require quite high oscillator voltage injection and are therefore rarely employed, although in the case of suppressor injection, interaction between the oscillator and signal circuits is negligible. Inductive, capacitive or combination coupling to the signal circuit can be employed but is quite difficult to maintain in production, especially for high frequency operation. A small amount of signal circuit coupling is however sometimes employed where it is desirable to compensate for undesired coupling such as exists due to grid-cathode tube capacity when cathode injection is employed. This coupling, assuming the oscillator frequency is above the signal, is out of phase with the oscillator voltage, or if the oscillator frequency is below the signal frequency the induced coupling voltage is in phase with the oscillator voltage. Other factors (images, frequency range) besides coupling effects must be considered in deciding whether the oscillator should be above or below signal frequency.

Because of the low grid-plate capacity in the pentode, loading of the signal circuit due to feedback through this capacity is ordinarily not serious.

In frequency converter service the advantages of pentodes may be summarized as follows: high conversion transconductance, good signal-to-noise ratio, high plate resistance and low grid-plate capacity. Disadvantages are, interaction between signal and oscillator circuits when the signal and oscillator are injected on the same grid, transit time and cathode lead inductance at high frequencies. The effect of the latter may be reduced by special design such as in the type 1204.

Pentagrid Converters and Mixers

The ordinary pentagrid converter, as represented by the 6A8GT and other tubes of similar construction having built-in oscillator sections, are only suitable for operation up to approximately

10 mc. The reasons for this will be discussed after considering the arrangement of the elements making up the tube.

Referring to Fig. 4A, the electron stream leaves the cathode in pulses due to the oscillator voltage developed by the oscillator grid (G_1) and anode (G_2). It should be noted that G_2 consists of two rods located physically in such a manner that they are in line with the other grid supports. In this way they have little influence on the main electron stream but depend mainly on secondary emission from the screen (G_3). The pulsating current from the oscillator forms a virtual cathode between G_3 and G_4 due to the geometry and the voltages on these elements. The signal grid (G_4) controls the amount of current passed on to the plate from this virtual cathode. It is evident then, that both the signal and oscillator voltages effectively modulate the plate current resulting in a sum or difference frequency (i.f.) being produced.

Several disadvantages however are inherent in the design. (1) Tubes of this construction have relatively low oscillator transconductance and therefore the oscillator performance is rather poor at high frequencies. (2) Due to variations in the space charge at the virtual cathode by the oscillator, a current at the oscillator frequency will flow through the signal grid circuit which is out of phase with the normal oscillator voltage, assuming the oscillator to be above the signal in frequency, and will result in a demodulating effect or reduction in conversion gain. (3) Since the signal voltage controls the electrons taken from the virtual cathode, it affects the capacity of the oscillator section and results in variations in oscillator frequency.

In the pentagrid mixer, such as the 6SA7 or similar types, the effect of such oscillator frequency shift is minimized by mounting collector plates on the side rods of the screen grid (G_2) as shown in Fig. 4B. These plates intercept some of the electrons returning from the virtual cathode to the main cathode with the result that signal voltages have less effect on the oscillator frequency. With this type tube oscillator voltage may still appear on the signal grid, particularly if the percentage difference between signal and oscillator frequencies is small and the impedance of the signal circuit at the oscillator frequency is appreciable. Such voltage may be effectively neutralized by the addition of a small capacity connected between G_1 and G_3 . If the neutralizing capacity used is below optimum in value the result will be a reduction in conversion transconductance. Should the capacity be too great, grid current will flow, which will load the input circuit; or if the neu-

tralizing capacity is increased still further, serious interaction between oscillator and signal circuits will result.

Neutralizing should be adjusted at the highest frequency of operation and the amplitude of the oscillator voltage should be fairly uniform throughout the frequency band to be covered. Operation is usually satisfactory, except for poor signal-to-noise ratio, at frequencies as high as 30 to 50 megacycles.

The type 6L7 pentagrid mixer tube, which requires a separate oscillator source, results in very little interaction between signal and oscillator frequency circuits. In this type tube (see Fig. 4C) the signal is applied to G_1 and the oscillator is injected into G_3 which is effectively shielded by a screen grid (G_2 and G_4). A suppressor grid (G_5) between the screen and plate gives the tube a pentode characteristic. In operation a signal on G_1 controls the cathode current, while the oscillator voltage on G_3

alternately passes or stops the flow of electrons depending on whether it is positive or negative at a particular instance. This in effect modulates the signal voltage and produces the desired (i-f) sum or difference frequency.

Another converter tube known as the triode-hexode is essentially two tubes in one. The arrangement of elements is shown in Fig. 4D. The anodes of each section are on opposite sides of the cathode. The oscillator grid, as can be seen, is situated between the cathode and screen as in the pentagrid converter; in fact, this tube operates in much the same manner. The oscillator section transconductance can be made relatively high and the presence of the shield at the cathode effectively eliminates interaction between oscillator and signal circuits, making the tube more desirable for high-frequency operation.

In general, pentagrid converters or mixers have a relatively poor signal-to-

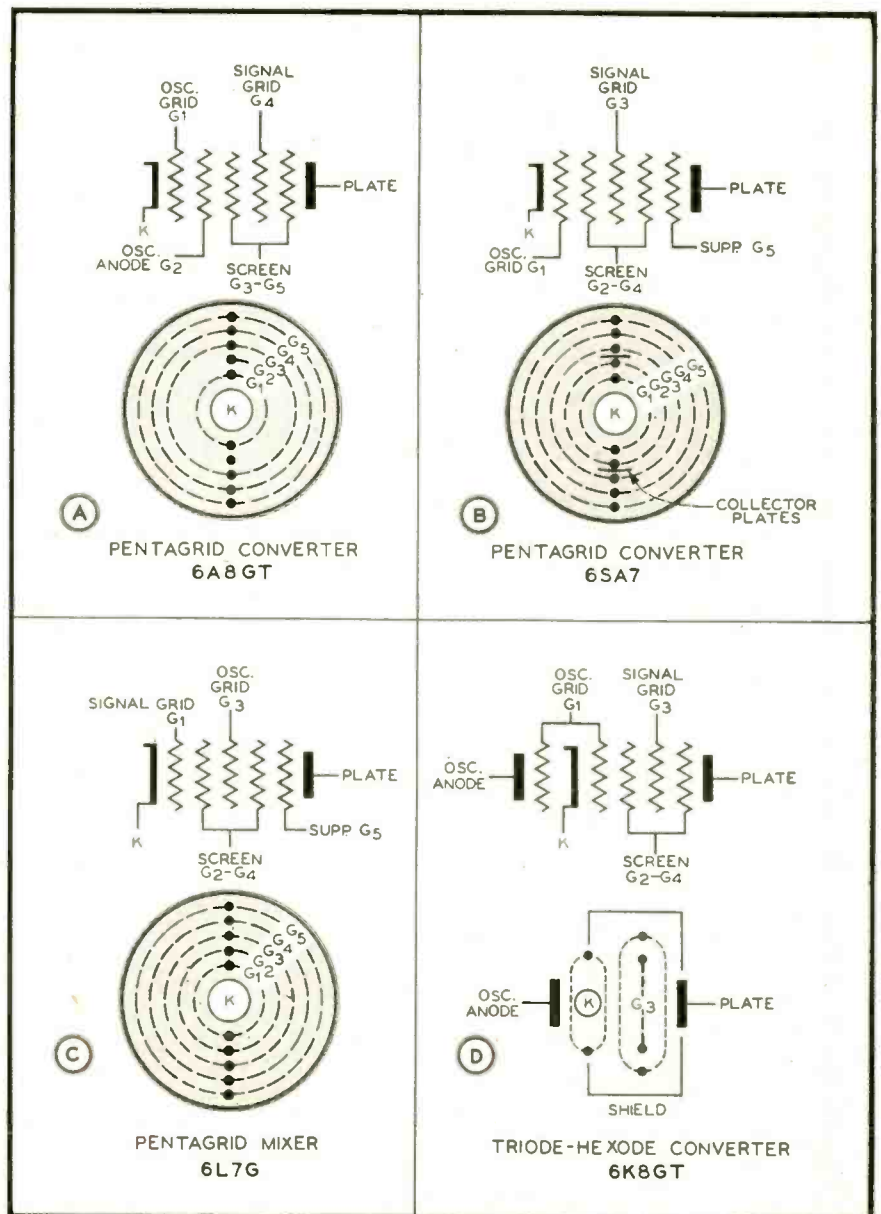

Fig. 4. Element arrangements of typical mixer and converter tubes

noise ratio in comparison with triodes and pentodes and are seldom used at UHF.

UHF Converters

As the operating frequency of a receiver is increased it becomes more and more difficult to obtain satisfactory frequency conversion. Ordinary tubes must be replaced by special types designed specifically for these frequencies. These too, eventually fail to function as the frequency is increased beyond a certain point, above which, specially designed crystal rectifiers must be employed.

Diodes

Although diodes and crystals were among the first known forms of detectors it has only been in the last few years that these devices have been developed to such a state that they are now commonly used as converters in superheterodynes. This has been due partly because, until the useful radio spectrum was extended to the near microwave region ordinary receiving tubes fully satisfied the requirements. As the useful frequency range expanded, such factors as transit time, lead inductance and input resistance became of importance, and the necessity for eliminating their effects was imperative. This has been at least partially accomplished by the use of special diodes and crystal converters. There is however, a need for considerable more development along these lines.

Diodes in general give low conversion gain (less than unity) when used as frequency converters, the signal-to-noise ratio is rather poor, they have a high oscillator harmonic response and they produce an appreciable damping effect on the signal circuit. Offhand such features would discourage most designers, but if each of these characteristics is investigated it will be found that the diode is not such a poor device after all. Conversion gains of less than unity are not too unreasonable if one considers how much gain can be obtained with other type tubes in the microwave region. In other words some signal is better than no signal at all. The fact that the oscillator harmonic responses is high is very fortunate indeed since this permits operation of the local oscillator at a comparatively low frequency where its stability is greatly improved. This characteristic alone is worth a great deal since the frequency drift of the receiver is dependent mainly on the stability of the local oscillator.

The effects of damping on the signal input circuit, which incidentally is due to grid current, can be decreased by tapping the diode down on the input coil instead of connecting across the entire inductance as is the usual practice. It may appear surprising that this does not

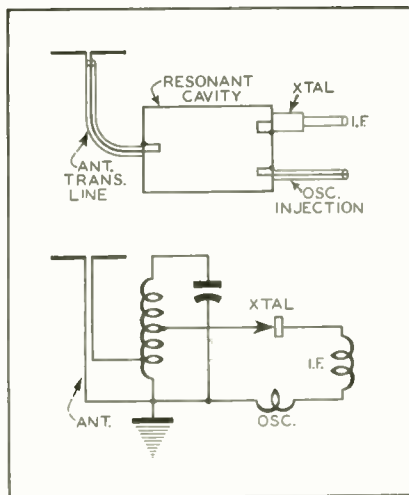

Fig. 5. Microwave crystal mixer application

necessarily result in less gain (unless carried too far) since, when the loading across the tuned circuit is reduced, the Q increases and nearly offsets the loss due to the step-down transformer effect.

Unfortunately, a diode converter will work in both directions; that is, the signal will be converted by the oscillator to an intermediate frequency and likewise the i.f. is reconverted by the same oscillator back to a signal frequency. The degree to which this occurs is dependent upon the impedance of the circuit elements to the two frequencies so the effect can be minimized by proper design, although it is always a factor in obtaining maximum converter efficiency.

Diodes should be operated with fairly high bias voltages (properly by-passed) and correspondingly high oscillator voltage injection. Under these conditions the conversion gain is relatively independent of small variations in oscillator amplitude and the output is essentially proportional to the input signal voltage.

The diode elements must be small physically and the spacing between anode and cathode should be close to minimize transit time effects. Small elements obviously result in increased conduction resistance which will impair the conversion efficiency, but a compromise design is possible whereby the loss due to conversion is only a few db as compared to a loss of approximately 10 to 12 db when a crystal is employed. Commercial diodes are now available for operation in the vicinity of 15 to 20 centimeters.

Crystal Mixers

In the past few years crystal detectors, as mentioned previously, have undergone some rather radical changes so far as physical dimensions and appearances are concerned. Instead of the unprotected delicate "cat whisker" of three decades ago which was always slipping off its sensitive point, the modern crystal resembles a small cartridge, completely enclosed, with the adjustment

more or less permanently fixed. Not only does the small size increase the resonant frequency so that operation in the microwave region of a few centimeters is possible, but it makes them particularly suitable for use in wave guides, resonant cavities and transmission lines.

Crystals are subject to erratic operation when their resonant frequency is approached either by the fundamental signal or its harmonics. It is therefore imperative that the unit be designed in such a manner that the series resonance is well above the operating frequency. Resonance is caused by the series inductance of the contact lead and the capacity across the crystal element.

Another limitation in the use of crystals is their efficiency. This gradually decreases with an increase in frequency, due mainly to the capacity across the actual crystal element. The capacity of this so-called barrier layer acts as a by-pass to the voltage which would normally appear across the contact junction to the crystal. Obviously the higher the frequency the greater the by-passing effect. This can be minimized by proper design and is of little consequence in commercially available units up to at least 3000 mc.

Crystals, like diodes, are subject to what might be called reverse rectification. With the diode, as was pointed out previously, this is minimized by the proper choice of circuit parameters. In the crystal unit this effect can be minimized by plating the crystal element before it is imbedded in its fusible metal alloy mounting.

Probably the only characteristic of the crystal rectifier likely to prove troublesome is its inability to handle large signal voltages. When subjected to strong signals or r-f fields the unit may become permanently damaged. It is necessary for this reason to make provisions in the design of the equipment to prevent such overloads. In fact, it is recommended practice to keep spare units in a shielded can or wrapped in metal foil. In spite of this disadvantage, and the fact that crystals are not as uniform in characteristics as diodes, they make much better detectors or mixers for centimeter applications than any type of tube now available.

A typical design application for a centimeter converter is shown in Fig. 5. Note the small coupling loop inserted in the resonant cavity. Oscillator injection is accomplished in a similar manner. Conversion gains, as with the diode, are less than unity. A typical unit in microwave application may result in a loss of approximately 10 db.

¹ Herold—Frequency Converters for Superheterodyne Reception—*Proc. I.R.E.*, Feb. 1942

RECENT RADIO INVENTIONS

These analyses of new patents in the radio and electronic fields describe the features of each idea and, where possible, show how they represent improvements over previous methods

Device for Measuring Peak Currents

★ The invention described in a patent issued on June 19, 1945, to Clarence W. Hansell is a very simple circuit that is claimed to be useful in measuring peak currents which must often be known in order to determine the limiting condition of operation of rectifiers. Whenever a rectifying circuit is followed by a filter containing capacitive elements, a charge is normally supplied to the condensers so that they obtain a voltage approximately equal to the peak voltage of the rectifier system. With lossless condensers the equality is exact in the absence of any load and no further current is drawn through the rectifier; once the condenser charge has been accumulated. When a load is applied, the condensers are somewhat discharged between cycles but can be recharged by the rectifiers only during the time when the applied voltage is greater than that across the condenser. In general, this will be the case only at the peaks of the sine wave input and in certain cases the rectifiers will be called upon to deliver much larger currents than that which exists in the load. For example, if a 10 μ f condenser is connected across a 200 volt peak, 50 cycle full wave rectifier and a 10 ma load applied, 0.0001 coulombs of charge will be withdrawn from the condenser between consecutive

half-cycles. This will be sufficient to decrease the condenser voltage by 10 volts. A normal 200-volt sine wave exceeds 190 volts only 20% of the time. This means that the rectifier current is five times the load current or 50 ma.

To measure such peak circuits at the high voltage level usually occasioned by most rectifier applications, the accompanying circuit was devised. A sufficiently small resistor so as to have a negligibly small effect on the current to be measured is inserted into the current lead out of the rectifier. An added rectifier and condenser is connected across this resistor and together with a high impedance voltmeter they show the peak voltages generated across the small resistor. By Ohm's law it is easy to convert this reading to one of current. The patent is assigned to RCA and is number 2,378,846.

Coupling Device

★ A patent concerning the inductive coupling of two high frequency circuits so that one is not influenced by unequal voltage or ground circuit currents in the two legs of the other was issued to Chester B. Watts on February 6, 1945. The problem is occasioned by unbalance in high-frequency transmission lines. Although the two conductors of such a line are normally designed to have the same voltage excursion about a con-

stant voltage level with respect to ground, it is difficult practically to obtain an exact equality. Such a condition or a similar situation in which unequal currents flow in the two sides of the transmission line are referred to as unbalance. When such an undesired effect is obtained, it is the purpose of this invention to remove the unbalance by inductively transferring the signal to another transmission line.

In normal loop coupling, unbalance is not removed. When two coils or loops are simply placed in the vicinity of each other and tuned to a desired frequency, energy is transferred between them by virtue of a magnetic field arising from current in the primary. Unbalanced current can cause voltage to be induced just as well as can the desired and balanced component.

In the present invention as shown in the figure, the effect on the secondary of unbalanced currents in the primary is eliminated by causing one loop to serve as a coaxial shield for the other. In that way voltage gradients to ground are entirely eliminated from the inner loop. As is the case with any inductive coupling, it is highly desirable that the structure be tuned to the frequency which it is desired to transfer. This may be accomplished by dimensioning the length of the coaxial sections so that they are effectively a quarter wave

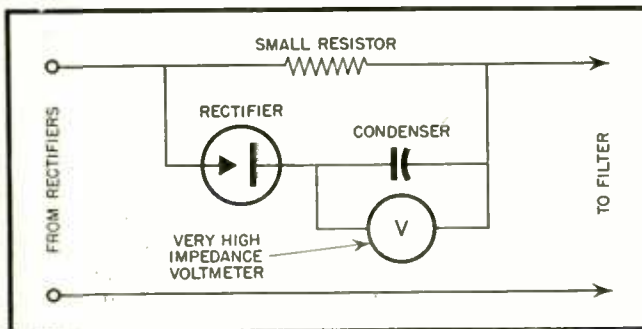

Patent No. 2,378,846

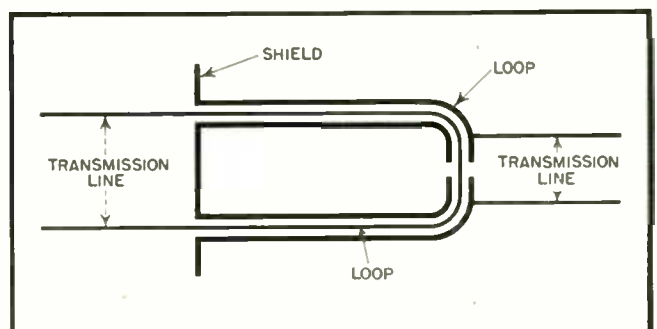

Patent No. 2,368,694

length long or by tuning the loops with a variable condenser or shorting bar that is placed across the outer loop at a proper position.

The patent, No. 2,368,694, is assigned to Federal Telephone and Radio Company.

Radio Altimeter and Panoramic Reception System

★ Marcel Wallace received a patent on June 19, 1945, for an ingenious but simple method of using radio signals to obviate the possibility of mid-air collisions between airplanes flying in clouds or other conditions of poor visibility. The essential idea is that an altimeter in each airplane is caused to shift the frequency of a lower powered radio transmitter in accordance with the altitude of the airplane. A panoramic receiver, also carried by all airplanes, receives not only the signal from the airplane's own transmitter but also shows a signal for all other near-by aircraft. Thus each pilot is presented with a screen which shows not only his own altitude but also that of all adjacent ships. A supplementary device may be added so as to give a visual or aural alarm whenever another airplane is in the same neighborhood as the airplane in question.

The figure shows a block diagram of the apparatus required. A saw-tooth generator which sweeps the beam of a cathode ray tube is also used to change the frequency of a local oscillator in a superheterodyne radio receiver. The output of the heterodyne converter is fed into a sharply tuned intermediate frequency amplifier capable of passing a signal of only a certain frequency band. The frequencies emerging from the converter are various and constantly changing since they arise as a difference

frequency between a received signal and the ever-changing local oscillator frequency. At an appropriate time each received signal bears a proper relation to the local oscillator so as to send information through the intermediate amplifier and cause a vertical trace on the cathode ray tube. Because of the synchronization of the local oscillator sweep frequency with that of the cathode ray tube sweep, position on the cathode ray screen may be interpreted as frequency of the received signal and hence as altitude of the corresponding airplane.

Because the signal from the airplane's own transmitter may normally be expected to give too strong a signal into the airplane's own receiver, it is necessary to provide a method for removing the transmitter power momentarily as the receiver sweep passes through that frequency band. This is done by a separate intermediate amplifier which is broadly tuned so as to operate a keying element on the transmitter whenever an overly strong signal is received from any source at any frequency.

Mr. Wallace also includes in his patent many elaborations of the scheme just described and points out how it may be used in conjunction with fixed ground installations to perform several other functions. The patent is assigned to Panoramic Laboratories of New York and is numbered 2,378,604.

Direct Current Voltage Amplifier

★ In a patent issued May 15, 1945, to Wesley M. Roberds and Benjamin F. Wheeler, a magnetically controlled vacuum tube is shown which is claimed to be useful for amplifying low power signals from low impedance sources, such as thermocouples. For example, in the surface hardening of steel it is de-

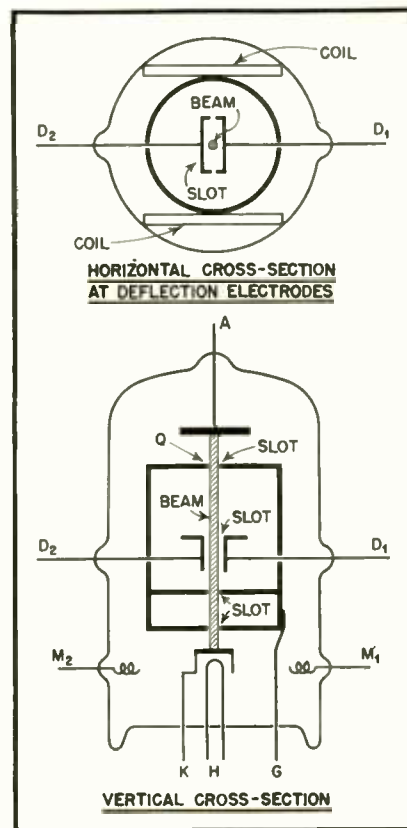

Patent No. 2,375,948

sirable to obtain graphic records of the temperature changes which occur in the surface layers of the material. Small thermocouples can be used to measure such temperatures but since the cycle is often as short as a tenth of a second it is imperative that the signal appear in graphic form on a recorder. At the low voltage available from the thermocouple, the recording pen's excursion is not great enough and amplification by ordinary vacuum tubes is unsatisfactory because of the large variance between the thermocouple impedance and the input grid impedance of most vacuum tubes. In the present invention this difficulty is circumvented by using magnetic coils to control the electron beam instead of depending upon a grid.

In the vertical cross section view shown in the accompanying figure the magnetic control coils are not shown since their orientation, which makes their planes parallel to the plane of the paper, would cause one of them to hide the view of the various electrodes. They are, however, shown in the horizontal section view and have the effect of creating a magnetic field directed in or out of the paper in the vertical view. Such a magnetic field, which is in accordance with the thermocouple voltage connected through the coils at terminals M_1 and M_2 , bends the beam either to the right or left and causes it to strike the electron gun electrode at the anode, A . Electrodes K , H , and G are the usual ones necessary to produce a

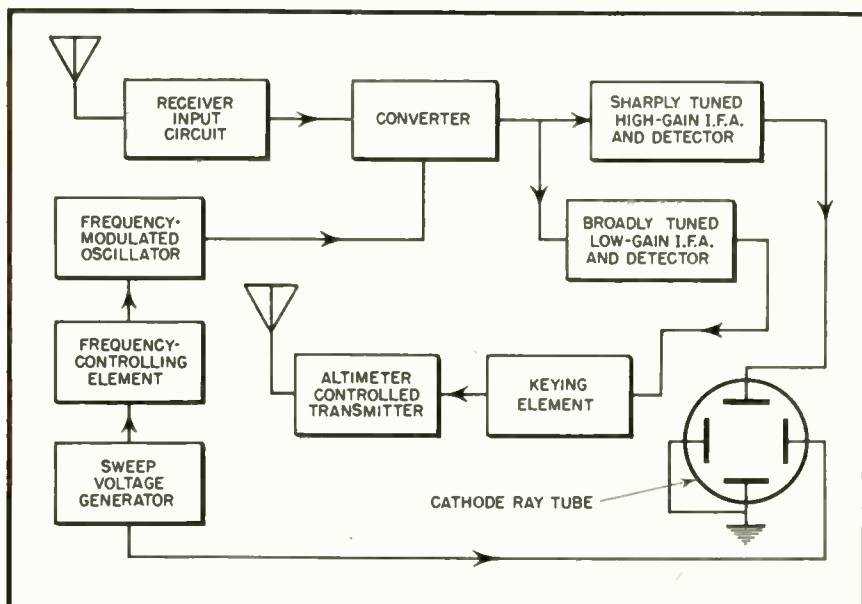

Patent No. 2,378,604

ribbon-like beam. Electrodes D_1 and D_2 are adjusted to proper d-c levels so as to assure proper centering of the beam in the absence of an input signal. An output signal from the tube is obtained across a plate resistor in the usual way.

This signal is usually amplified further by ordinary means since the tube described is not so much a power amplifier as it is a device which is capable of transforming very low impedance into relatively high impedance. In many cases like the one cited this is a difficult thing to do by standard methods. A transformer cannot be used because the voltages are all d.c.

The patent is assigned to RCA and is numbered 2,375,948.

Phase Angle Indicator

★ The numerous standard methods of measuring the phase angle between two alternating current voltages were added to on March 6, 1945, in a patent issued to James E. Shepard. According to the patent, the new method is superior because it does not require identical amplitudes of the voltages being compared, because it produces a simple direct-reading device that shows phase angle on a meter with a linear scale that is free of ambiguity, and because it is, within limits, independent of the frequency and exact wave form of the signals being measured. Older methods which include schemes that measure the sum or difference of the amplitude of two sine waves of identical amplitude, and null methods which require the generation of a known phase by mixing in known proportions two waves that are 90 degrees out of phase, do not fulfill all these requirements.

The essence of Mr. Shepard's invention lies in the determination of two time periods whose ratio is a measure of phase. A reference point on one wave is chosen (he actually uses the point where the voltage passes through zero

while heading in a positive direction) and the time elapsing between that point and the occurrence of the same point on the other wave is a one time period. The second time period is formed by the time between the occurrence of the reference point of the second wave and the recurrence of that point in the next cycle of the first wave. These time periods are caused to operate the on-off characteristics of a pair of vacuum tubes connected as a biased multivibrator. The tubes in turn move a meter movement to the right or left and hence indicate phase in accordance with the relative time which they have to send a charge through the meter movement.

In the figure is shown a connection which constitutes one form of the invention. The two sides are identical and are respectively made to influence one or the other of the dual coils in the meter. The coils are so arranged that they compete in moving the indicating needle. Tubes A and H are straight amplifiers which give the input waves large amplitude. Tubes B and G limit these waves severely (to a volt or less) so that they become flat-topped but still cross the zero axis in the same way as they originally did. The condenser-resistor networks out of the limiter tubes thus pass signals only during the time while the original waves are going through zero and only the proper ones of these possess a voltage of a polarity proper to influence tubes C and F . The outputs of tubes C and F are caused to switch properly a condition of conduction between tubes D and E and give the proper action to the meter. The patent, number 2,370,692, is unassigned.

Homing Autopilot for Aircraft

★ In a patent which was first applied for in 1935 but not issued until March 27, 1945, Bert G. Carlson describes an invention which allows an airplane equipped with an automatic pilot to fly

automatically toward a selected radio station without being influenced by wind which would normally cause the flight path to be curved. As is now common practice with automatic pilots, gyroscopes establish stable directions in space and through servo systems control the rudder, tail surfaces, and ailerons of the airplane so as to cause the airplane to head along a desired direction. For example, a so-called directional gyroscope is one which acts precisely like a compass except that it is stable against vibration and short-term torques which grossly disturb a magnetic compass. The pointer on such a gyro does not necessarily indicate north; it can equally well be set to point in any desired direction. If the directional gyro is set to indicate west, the automatic pilot is given a signal which causes it to change the control surfaces of the airplane and keep them in a deflected position until a westward course is obtained. When the desired course is reached, the control becomes correct for straight and level flight.

Another instrument, called an altitude gyroscope, performs a similar function to keep the airplane level. Thus, when an airplane flies on an automatic pilot it continues to fly a straight and level line in accordance with any set course.

The present invention consists of a mechanism which sets the directional gyroscope in accordance with information from an automatically driven radio loop antenna and furthermore supplies the automatic pilot with an error signal which causes compensation for a wind which may be blowing across the airplane's course. The accompanying figure illustrates the problem that is involved. If an airplane at A turns on the equipment the loop antenna lines up on the transmitter and causes the airplane to quickly orient itself so as to head toward the transmitter. If no wind is present, flight proceeds directly to the

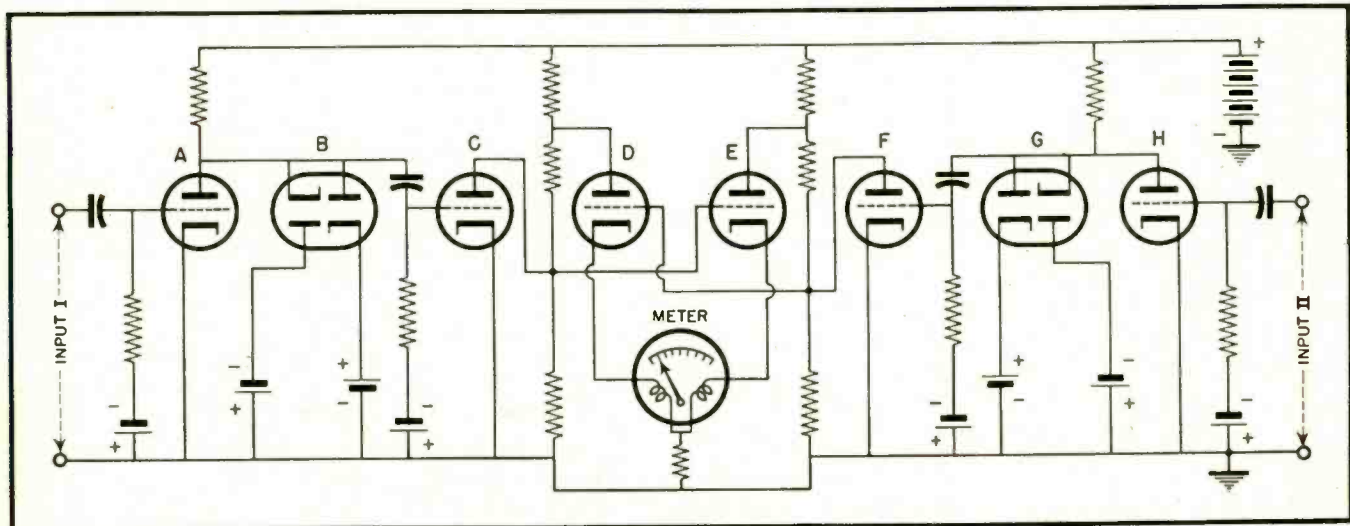

Patent No. 2,370,692

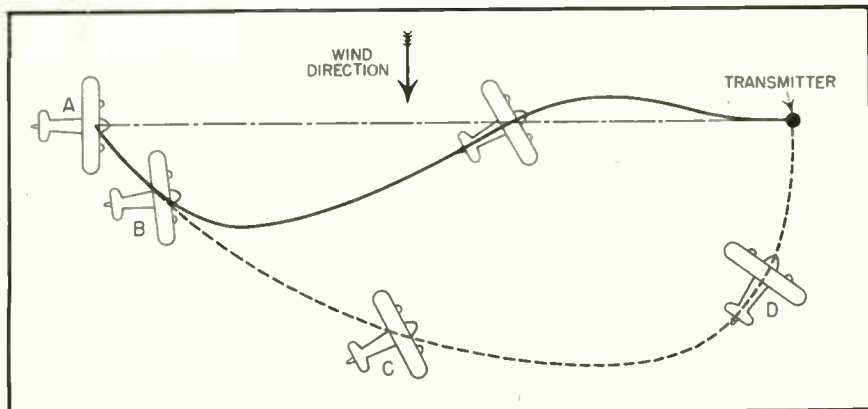

Patent No. 2,372,184

transmitter along the dot-dash line shown. If a wind, as shown, is blowing and no drift correction system is used, the airplane successively takes up positions B, C, and D and finally reaches the transmitter by moving along the curved path shown by the dotted line. The automatic pilot continually changes the setting of the directional gyroscope so as to keep the airplane pointed toward the desired goal but because of the wind, the motion of the airplane is not in that direction.

Drift correction may be obtained by having the setting of the directional gyroscope be influenced not only by signals from the loop antenna but also by its own rate of change. Thus, with drift correction equipment installed the airplane might start to move along the dotted path as before, but the fact that the heading was slowly and steadily changing is interpreted as an error signal and by the time B is reached, that signal accumulates enough strength to turn the airplane faster. Under such conditions the airplane will follow a path of the type illustrated by the solid line. Under auspicious adjustment this course can be made to approximate that of the desired straight line. A sample mechanism which might create the proper correction is a motor with a large step-down ratio which drives the directional gyroscope setting beyond the point to which the antenna wishes it to go whenever a prolonged motion in one direction is encountered. The patent is assigned to the Sperry Gyroscope Company and is number 2,372,184.

Stabilized Oscillator

★ In a patent granted to William E. Edson on July 3, 1945, a thorough discussion of the stability problems of feedback oscillators is given. The invention is a logical result of the analysis and in effect constitutes the addition of electronic control of the feedback energy plus the insertion of additional tuned circuits to obtain further improvement in the frequency stability characteristics. The chief advance lies in the use

of a rectified portion of the oscillator output to control the gain of the oscillator tube so as to maintain a steady oscillation amplitude.

In the accompanying figure is shown the schematic of a stabilized oscillator as the invention visualized it in one form. Use is made of well-known stabilizing methods, such as the inclusion of a bridge in the feedback line, but a full-wave rectifier is also used to modify the grid voltage of the oscillator triode. The resistors in the bridge may, for example, have a resistance much larger than the cold resistance of the lamps which make up the other two arms of the bridge. As the input to the bridge is increased the feedback also increases only up to the point where heat has so raised the tungsten lamp resistance that the bridge comes close to balance. If balance is ever reached the feedback falls to zero. In the region where increased signal into the bridge will actually cause a falling off of the feedback strength because of an approach to balance, a stable point of operation will be found. There, an increase in oscillator amplitude for any reason at all will cause a diminution in feedback and a consequent return to the original oscillator level.

The only difficulty that is encountered when this type of stabilization is used alone is that the lag in the lamp heating and cooling may cause an enhancement of low frequency variation. When the lamps heat up, they are carried to too high a temperature by energy stored in the various resonant circuits. When this happens the oscillation is then cut to too low a level and the cycle of events may repeat indefinitely.

These problems led to the inclusion of a rectifier that forms a d-c voltage across condenser A loaded with resistor R. As long as the oscillator output is constant, condenser B prevents any current flow through resistor S and no drop appears across S. When the oscillator level changes, however, condenser B either loses charge or receives additional charge. This charge reaches B through resistor S and in transit causes an appropriate voltage to appear and change the operating level of the grid of the oscillator triode. The patent is assigned to Bell Telephone Laboratories and is number 2,379,694.

Frequency Modulation Detector

★ The possibility of obtaining a combined limiter and discriminator in a single triode tube envelope is considered in a patent issued to George C. Sziklai on April 10, 1945. He uses the fact that super-regenerative quenching occurs at a given amplitude of oscillation to provide the limiting action. The fact that two tubes with circuits which are respectively tuned to opposite sides of the center frequency have different build-up times, provides a method of frequency discrimination.

In the figure it will be noticed that each vacuum tube is essentially connected like a Hartley oscillator except that because of the grid-leak and grid-condenser arrangement real self-oscillation is never obtained. Whenever current

[Continued on page 79]

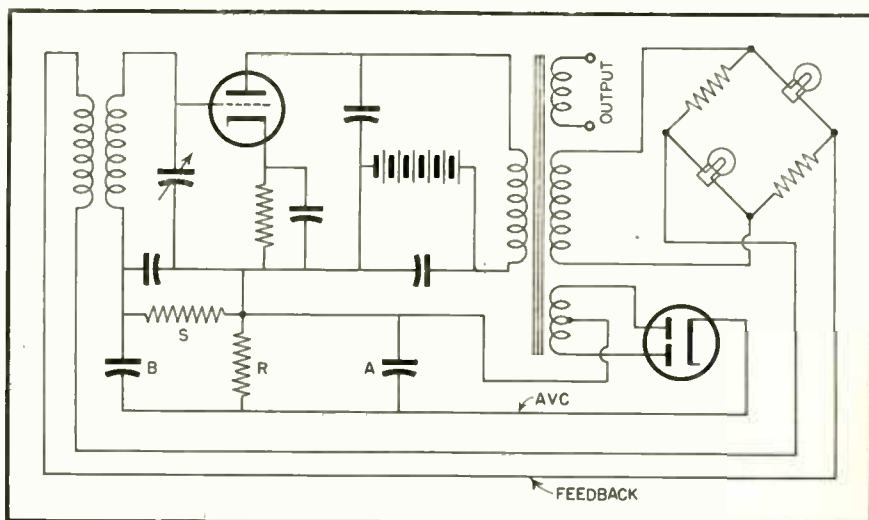

Patent No. 2,379,694

RADIO DESIGN WORKSHEET

NO. 40 – INDUCTIVE BALANCE ANTI-NOISE CIRCUIT

INDUCTIVE BALANCE ANTI-NOISE CIRCUIT

In *Fig. 1* is shown a balanced coil. If the primary coils are inductively and capacitively balanced then each will induce an equal voltage in the secondary *B* if the same voltage is applied to 1, 3 and then to 2, 3 in turn. If the voltages have the sense indicated by the arrows of *Fig. 1*, then for perfect balance equal opposing voltages are induced in secondary *B* and no current will flow in that circuit.

If one of the primary voltages is reversed as shown in *Fig. 2*, then the

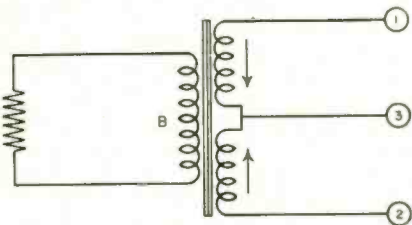

Figure 1

voltages induced in *B'* will be in phase and a current will flow in the secondary circuit. Suppose two balanced transformers are connected as shown in *Fig. 3*; when voltage is applied to the primary loop in phase, voltages will be induced in secondaries *B* and *C* and currents will flow in these circuits. Since the transformers are assumed to

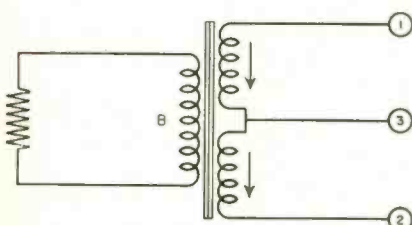

Figure 2

be balanced and identical, the voltage between terminals 3 and 5 will be 0. Consequently these points may be connected without altering the situation.

If the primaries of the two transformers are cross-connected, as shown

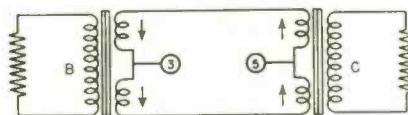

Figure 3

in *Fig. 4*, but otherwise the conditions of *Fig. 3* obtain, then we have for each transformer the conditions of *Fig. 1* and no voltage will be induced in either secondary.

In *Fig. 5*, we apply voltage *E* to winding *B*, leaving the winding cross connected as in *Fig. 4*. For this case no voltage is induced in secondary *C* and no current flows in the cross-connected loop, so no voltage can be induced in secondary *C*.

Next, let a connection be made as

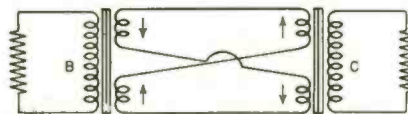

Figure 4

shown at 3 in *Fig. 6*. The arrows again indicate direction of current flow. In this case current can flow around the cross-connected loop and a voltage will be induced in secondary *C*, and current will flow in that circuit. Obviously the connection at 3 may be made by relay contacts. This is a connection sometimes used for silencing in anti-noise circuits. Such an arrangement is shown in *Fig. 7*.

When a continuous direct current flows through the relay winding from

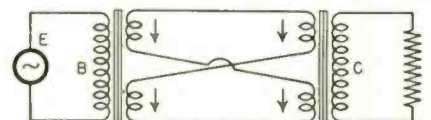

Figure 5

rectifier *R* as would be the case if a signal voltage wire impressed on the rectifier input, the relay would be energized and the contacts would close, allowing signals to pass through the

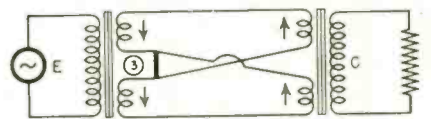

Figure 6

cross-connected circuit. However, when noise pulses of short duration only act on the rectifier, the relay would remain balanced, permitting no noise current to be induced in secondary *C*.

The above discussion is employed to illustrate the principle of this type of anti-noise circuit. In actual practice, the relay contacts are usually closed except when the rectifier is energized, to reduce syllabic clipping. This arrangement will be discussed more fully in a future worksheet.

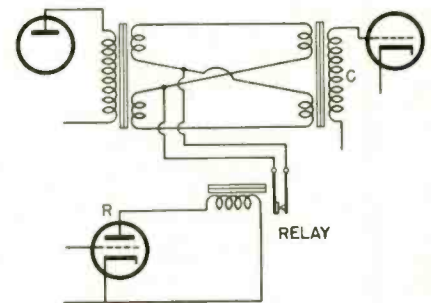
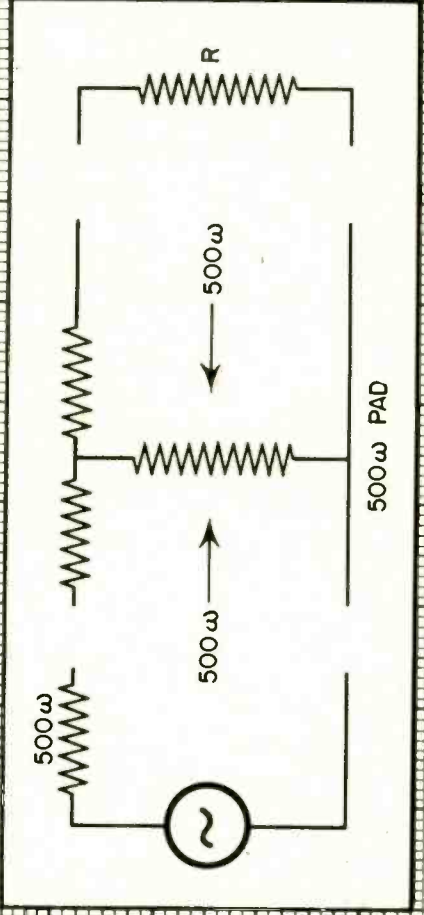
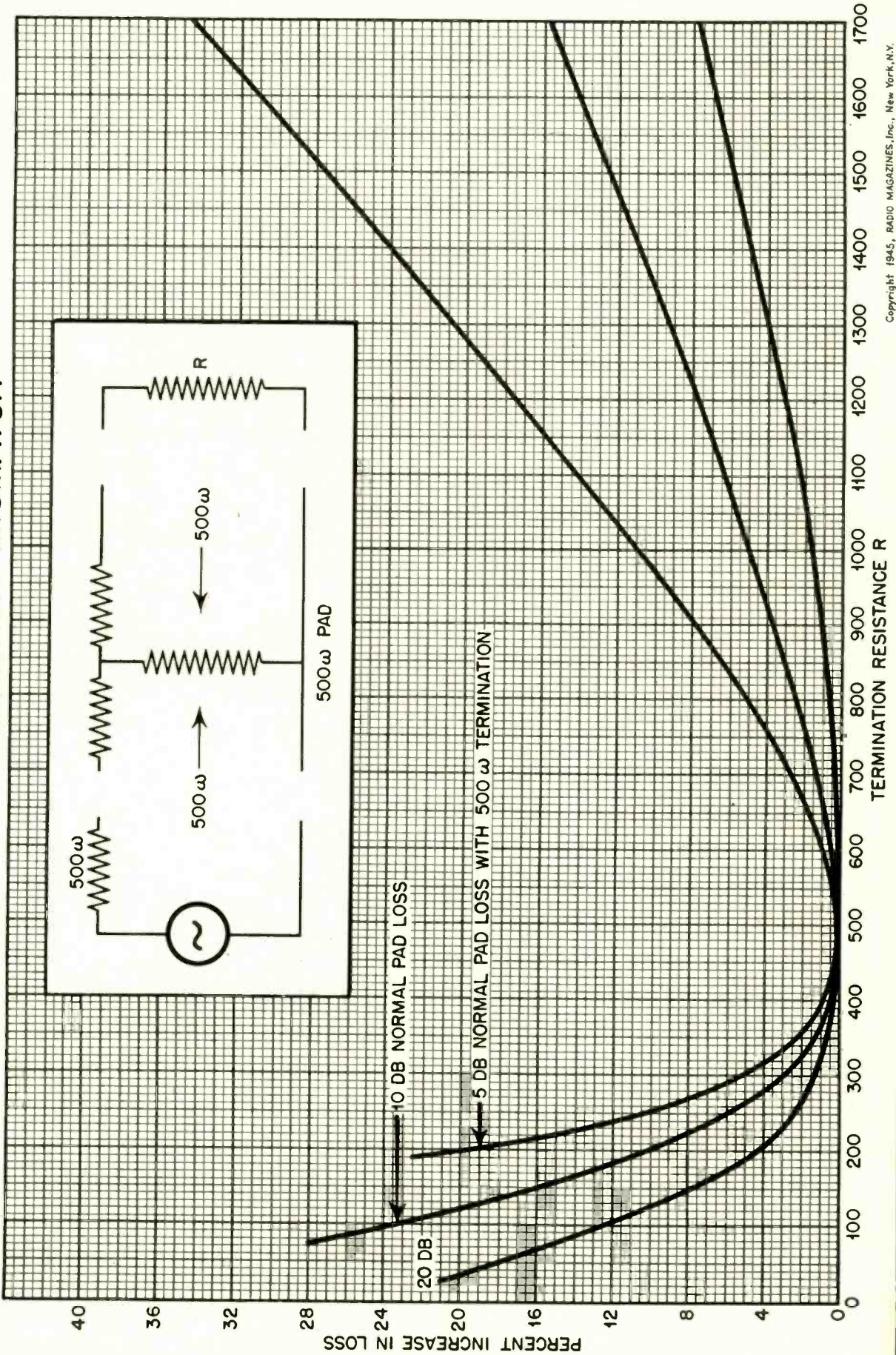

Figure 7

INCREASE IN LOSS OF RESISTANCE PAD OF 500ω ITERATIVE IMPEDANCE DUE TO TERMINATION MISMATCH



Copyright 1945, RADIO MAGAZINES, Inc., New York, N.Y.

THEY'LL HELP YOU BUY AND USE CAPACITORS...EFFICIENTLY!



Up-to-the-minute CAPACITOR and APPLICATION DATA



HIGHER POWER IN LESS SPACE

with this new 200° C.
Class C Insulation

Manufacture coils, transformers, or similar wire wound devices? Then you owe it to yourself to investigate the tremendous possibilities of *CEROC 200—the Sprague inorganic, non-inflammable wire insulation that permits continuous operation to 200° C.

Write for Bulletin 505

A lot of time and effort has gone into making these new Sprague Catalogs invaluable guides to modern Capacitor selection and use for all who buy or use Capacitors.

CATALOG 10 brings you up-to-the-minute data on time tested *Sprague Dry Electrolytic*

types for practically any application. CATALOG 20 does the same relative to the most modern line of *Paper Dielectric Capacitor* types on the market today. A copy of either or both will gladly be sent on request.

Write Today!

SPRAGUE ELECTRIC COMPANY • North Adams, Mass.

SPRAGUE

*Trademarks Reg. U. S. Pat. Off.

CAPACITORS — *KOOLOHM RESISTORS

This Month



Production line at Hallicrafters Company, Chicago, which is turning out high-frequency radio receivers for civilian use. A limited number is being shipped at the present time

FCC TESTS

The program of tests of FM transmission in the 44 to 108 megacycle region of the spectrum which was started in connection with the Commission's allocation studies will be continued to obtain propagation data needed in determining standards for making station frequency assignments in all services in this portion of the spectrum.

The need for this type of information was revealed in the recent allocation hearings. While there was much opinion testimony regarding propagation characteristics of frequencies in this portion of the spectrum, there was comparatively little factual information available.

Among the specific problems for which these tests should develop information are the problem of the proper distance between stations operating on the same and adjacent channels and the field intensities required for the various services under different conditions.

Following the tests in the 44 to 108 megacycle region, the Commission plans to extend the studies in cooperation with industry to higher portions of the spectrum.

AIREON ACQUIRES THREE MID-WEST COMPANIES

Aireon Manufacturing Corporation has purchased for \$400,000.00 cash, 100 percent of the stock of the Oxford-Tartak Company and the Cinaudagraph Corporation of Chicago, Ill. Both companies manufacture radio speakers, microphones and others electronic products. Randolph C.

Walker, President of Aireon, stated that the companies were acquired to insure an adequate supply of high grade speakers for use by Aireon. In addition, the companies will continue to supply other radio manufacturers.

Aireon has also purchased for \$250,000.00 the entire assets of the Midco Tool and Supply Company of Oklahoma City, manufacturers of oil well supplies and accessories. According to Mr. Walker, the



Oscar Hammarlund

research engineers of the hydraulics division of Aireon in Burbank, California, have developed certain hydraulic devices for oil field use which made necessary the acquisition of an operating in the oil field.

In discussing future plans, Mr. Walker stated that for every facility of its own, Aireon has a planned production program, and that the company will shortly be employing as many people as at the peak of war production.

PERSONAL MENTION

Norman E. Wunderlich

★ The appointment of Norman E. Wunderlich, long prominent in the radio industry, as executive sales director of radio equipment and allied products, has been announced by the Federal Telephone and



Norman E. Wunderlich

Radio Corporation, Newark, New Jersey, manufacturing associate of the International Telephone and Telegraph Corporation. He comes to Federal from the Galvin Manufacturing Corporation, where he was manager of the communications and electronic division.

M. L. Muhleman

★ M. L. Muhleman has joined the editorial staff of the trade and technical division of J. Walter Thompson Company. Mr. Muhleman was a former editor and publisher of "RADIO" and a writer for many trade and technical publications.

Oscar Hammarlund

★ Mr. Oscar Hammarlund of 285 Lincoln Place, Brooklyn, founder of the Hammarlund Manufacturing Company Inc., of New York, N. Y., died shortly after noon

[Continued on page 68]

CORROSION

is one saboteur
that VICTORY won't stop!

A Wartime Lesson for Postwar Shippers

In war there is no time for claims, returns and replacements. Precision parts, equipment, instruments must be ready to use—factory perfect—on arrival. The wartime answer to corrosion-proof, rust-proof, mildew-proof shipping has been Silica Gel within a moisture-proof barrier . . . known under government specification as Method H Packaging.

* Silica Gel is also the peacetime answer to this same problem of trouble-free, protected shipping.

Through the war, Sterling (Silica) Gel has helped to bring a vast tonnage of war materiel through to the most distant fronts ready for action. Always exceeding government standards, uniform, efficient, moisture-consuming Sterling Gel is now available to insure the safe arrival of peacetime products of all kinds in both domestic and export markets. Whatever moisture can harm, Sterling Gel can protect! Describe your product and ask for specific information.

STERLING GEL

Inquiries invited from sales agents and distributors

STERLING SILICA GEL COMPANY

STERLING, ILLINOIS

New Products

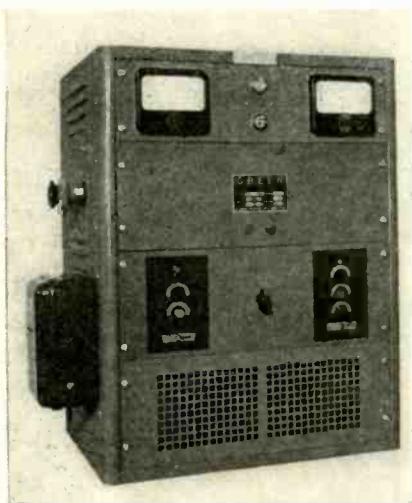

STABILIZED LOW VOLTAGE RECTIFIERS

High voltage low current rectifiers with electronic stabilization have been known for many years.

Green Electric Company announces further advance in the rectifier field—stabilized equipment with *low* voltage high current output.

The unit illustrated is rated at 200 amperes, voltage range zero to 3 volts. Any voltage selected in range is maintained to within 50 millivolts over load variation from zero to 200 amperes, and with line voltage variation of plus or minus ten percent.

Voltage stabilization system includes motor-driven Powerstat and simple electronic pilot device. Principle is widely applicable to larger or smaller rectifier units.

Descriptive data available from Green Electric Co., 130 Cedar Street, New York City.

IMPEDANCE BRIDGE

The Brown Engineering Company, 115 S. W. 4th Ave., Portland 4, Oregon, their model 200-A Impedance Bridge, a portable, self-contained instrument designed for the accurate measurement of capacitance, resistance, and inductance over wide ranges. It is also capable of measuring the stor-



age factor (Q) of coils and the dissipation factor of condensers.

The range of measurement for capacitance is 1 micro microfarad to 100 microfarads; for resistance, 1 milliohm to 1 megohm; for inductance, 1 microhenry to 100 henrys, according to the manufacturer. The accuracy on the main decade is said to be 1% for capacitance or resistance measurements and 2% for inductance tests.

For further data, write the manufacturer.

THE RADAMETER

The Radameter "sees" through darkness, fog, rain and snow for varied distances. All models built so far have been taken by the fighting ships of the Navy, but future Radameters are expected to be standard

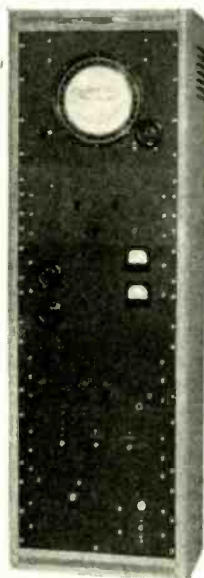

A commercial adaptation of radar apparatus designed for use on merchant vessels

equipment on most merchant vessels. They will eliminate the hazard of collision in the open sea or in congested harbors, no matter what the time of day or prevailing atmospheric conditions.

A fully automatic apparatus, the Radameter operates by beaming a short wave radio impulse away from the ship. The impulse bounces back as an "echo" when it hits any obstruction on the water.

The Radameter is manufactured by the Submarine Signal Co., 160 State St., Boston 9, Mass.

HEAVY DUTY SWITCH

The 043T-2 Heavy Duty Turn Switch illustrated is manufactured by Donald P. Mossman, Inc., 612 N. Michigan Ave., Chicago, Ill., and was especially engineered for radio and audio application. (The section of the shield is broken for

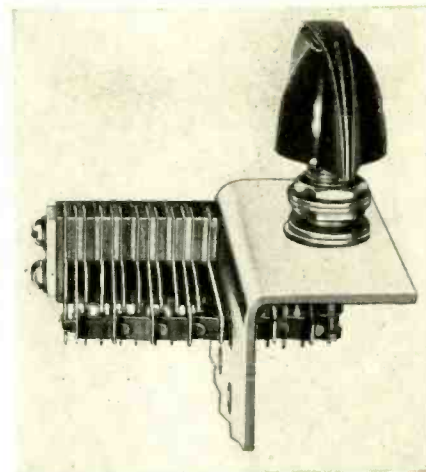

convenience of presentation). Mounted singly, complete isolation of radio and audio frequency carrying elements is achieved. Its action is unusual in that both frequency ranges can be controlled in the same unit assembly. The switch is easily mounted in a cast steel housing. The mounting bracket fits into a final electronic unit as a mounting for the switch and as a shield between various frequencies. Due to quality construction, the overall resistance at the soldering lugs is below .007 ohm.

The manufacturer will gladly mail a descriptive catalog upon request.

NEW U-H-F FREQUENCY METER

Type 720-A Heterodyne Frequency Meter is a compact, portable, battery-operated instrument for frequency measurements between 10 and 3000 megacycles. The internal oscillator covers a frequency range of 100-200 megacycles. For frequencies below 100 megacycles harmonics of the unknown frequency are made to produce beats with the internal oscillator. For frequencies above 200 megacycles, harmonics of the internal oscillator produce beats with the unknown frequency.

The internal oscillator uses the newly developed butterfly circuit in which capacitance and inductance are varied simultaneously. No sliding contacts are used in

[Continued on page 70]

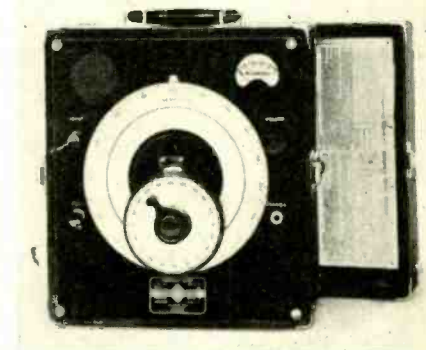

Compare the actual battery drain!*

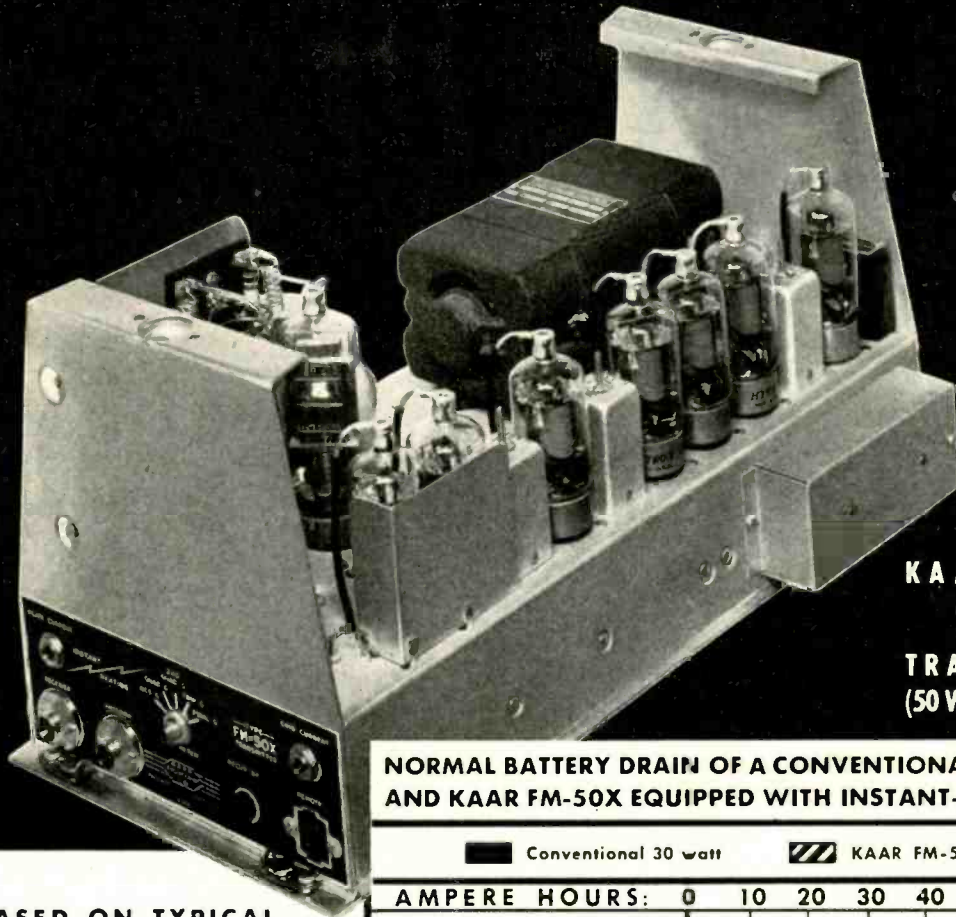

KAAR FM-50X
Mobile
TRANSMITTER
(50 WATTS OUTPUT)

NORMAL BATTERY DRAIN OF A CONVENTIONAL TRANSMITTER AND KAAR FM-50X EQUIPPED WITH INSTANT-HEATING TUBES

■ Conventional 30 watt ▨ KAAR FM-50X · 50 watt

AMPERE HOURS: 0 10 20 30 40 50 60 70

STANDBY DRAIN
24 HOUR PERIOD

55.2 AMPERE HOURS

0.0 AMP. HRS.—YET READY TO TALK INSTANTLY!

AVERAGE TOTAL
BATTERY DRAIN
24 HOUR PERIOD

56.8 AMPERE HOURS

2.2 AMPERE HOURS

* CHART BASED ON TYPICAL METROPOLITAN POLICE USE

(140 Radiotelephone-equipped cars operating three shifts in city of 600,000 population.)

MESSAGES ORIGINATED BY CARS	904
MESSAGES ACKNOWLEDGED BY CARS	932
TOTAL TRANSMISSIONS PER CAR	13
AVE. LENGTH OF TRANSMISSION	15 sec.
AVE. TRANSMITTING TIME 24 HOURS	3 min. 15 sec.

KAAR mobile FM-50X transmitter gives you 20 watts more output with only 1/25th usual battery drain!

KAAR engineers—who pioneered the instant-heating AM radiotelephone—have now, through the use of instant-heating tubes, made 50 and 100 watt mobile FM transmitters practical! Thus you gain greater power and range—along with a tremendous reduction in battery drain!

With instant-heating KAAR equipment standby-current is zero—yet the moment you press the button microphone you are on the air. Contrast this with conventional emergency transmitters, over 90% of which operate with the filaments "hot" during stand-by. Since sturdy instant-heating tubes eliminate this great waste of energy without slowing the handling of messages,

KAAR 50 and 100 watt transmitters can be operated from the standard ignition battery!

100 WATT MOBILE FM!

The KAAR FM-100X is identical to the FM-50X, except for the final amplifier. It puts 100 watts into a standard 34 ohm non-inductive load and is ideal for county and state police use. It requires no special batteries, wiring, or generator changes.

ADDITIONAL FEATURES

A new system of modulating the phase modulator tubes in KAAR FM transmitters provides excellent voice quality. Note that the equipment is highly accessible, and only two types of tubes are used. Frequency range: 30 to 44 megacycles.

Write today for free bulletin describing KAAR FM transmitters in detail. It's ready now!

KAAR ENGINEERING CO.

PALO ALTO

CALIFORNIA

Export Agents: FRAZAR AND HANSEN · 301 Clay St · San Francisco, Calif.

THIS MONTH

[Continued from page 64]

Saturday, August 25, 1945, at his home in Brooklyn at the age of eighty-three.

He leaves a son, Lloyd A. Hammarlund, and three grandsons, Lt. L. A. Hammarlund, Jr., Sgt. Frazier S. Hammarlund, and Roger Hammarlund.

Frank M. Folsom

★ Frank M. Folsom, who has been Vice President in Charge of RCA Victor Division since January, 1944, has been elected Executive Vice-President in Charge of RCA Victor Division, it was announced

by Brigadier General David Sarnoff, President of Radio Corporation of America, following a meeting of the Board of Directors. At the same time, John G. Wilson was elected Operating Vice President of RCA Victor Division.

Mr. Folsom joined RCA after serving in Washington as Chief of the Procurement Branch of the Navy Department. In addition to being in charge of RCA's manufacturing division, He is a Director of RCA and of the National Broadcasting Company. Before entering Government service, Mr. Folsom was Vice President in Charge of Merchandise and a Director of Montgomery Ward & Company.

Mr. Wilson has been in charge of financial administration at the RCA Victor Division for the last year. He came to

RCA from Chicago where he had been Executive Vice President of the United Wallpaper Company. Previously, Mr. Wilson served as Assistant Controller of Montgomery Ward & Company.

Haraden Pratt

★ Haraden Pratt, Vice President and Chief Engineer of the American Cable and Radio Corporation, was today elected



Haraden Pratt

Chairman of the Radio Technical Planning Board, the world's leading engineering group concerned with the technical future of the radio industry and related services. Mr. Pratt will take office October 1, 1945. He succeeds Dr. W. G. R. Baker, Vice President, General Electric Company, who has been Chairman since the RTPB was organized in September, 1943.

William E. Snodgrass

★ William E. Snodgrass, formerly executive vice president of the Dictograph Products Company, has joined the West-

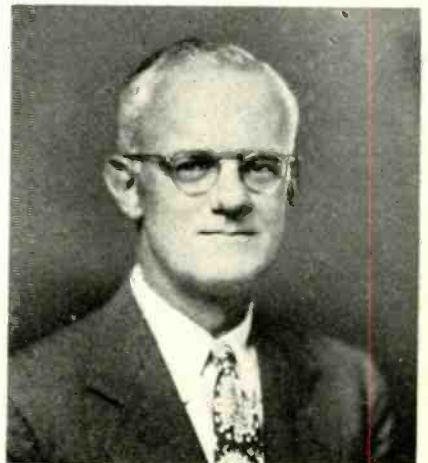

William E. Snodgrass

ern Electric Company as general manager of that company's hearing aid division, according to an announcement by F. R.

[Continued on page 70]



Now! Projection Welding of Two Studs to Housing in One Operation!

The series of P-20 Peer Welders were developed to provide manufacturers of sheet metal and wire products with automatically air operated machines capable of high speed precision projection and general spot welding. They are sturdily constructed, low priced, direct air operated, press type machines.

Shown above, is a Peer P-20 set up with safety guard which is so adjusted that, when lowered, it trips the switch and causes the welder to pass through a complete welding cycle before the machine automatically lifts the guard and stops, ready for the next operation. Other means such as a foot-switch control, can also be used to actuate the welding cycle.

The standard cylinders furnished with these welders provide nominal electrode force up to a maximum of 1000 lbs. Pressures are easily adjusted by the air pressure regulating valve. The welders may be operated with strokes suitable for work at hand within the range of from 0" to 3".

Shown at right, is the wrapper from a package of Wrigley's Spearmint Gum. This famous wrapper will remain empty until conditions permit Wrigley's Spearmint manufacture in quality and quantity for everyone. Wrigley's Spearmint Gum, will, one day, be back as "a help on the job" to workers in industry. Until then, we ask you to remember this wrapper as a guarantee of finest quality and flavor in chewing gum!

You can get complete information from Pier Equipment Mfg. Co., 8 Milton St., Benton Harbor, Mich.

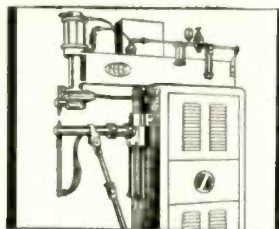

Air Operated Press Type Spot Welder



Remember this wrapper

Z-82

OHMITE RHEOSTATS and RESISTORS

IN
200 KW

Bethany Transmitters

From six of the world's mightiest shortwave stations, the "Voice of America" shoots "bullets of truth" to combat enemy lies. These transmitters, 200 KW each, located in Bethany, Ohio, were designed and built for the OWI by the Crosley Corporation.

The two interior photo-views of one transmitter reveal more than 60 Ohmite Resistors of various sizes . . . and one Ohmite Tandem Rheostat assembly.

The knowledge and experience that enabled Ohmite to "produce" on this psychological warfare job is at your service in solving resistance problems . . . today and post-war.

OHMITE MANUFACTURING COMPANY
4868 FLOURNOY ST. • CHICAGO 44, U.S.

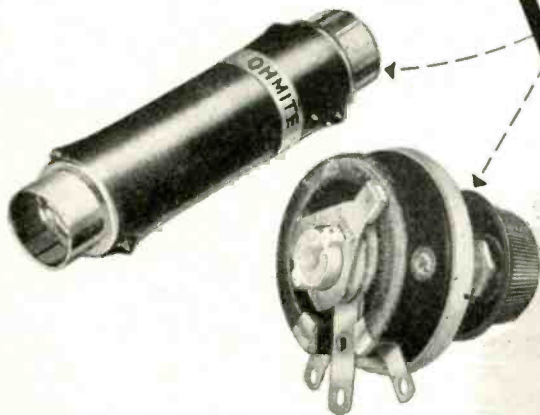
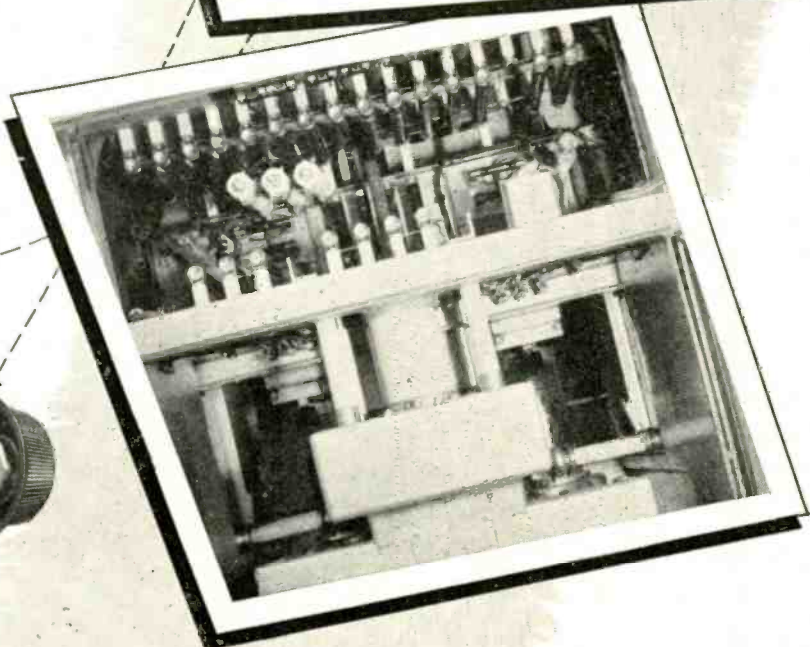
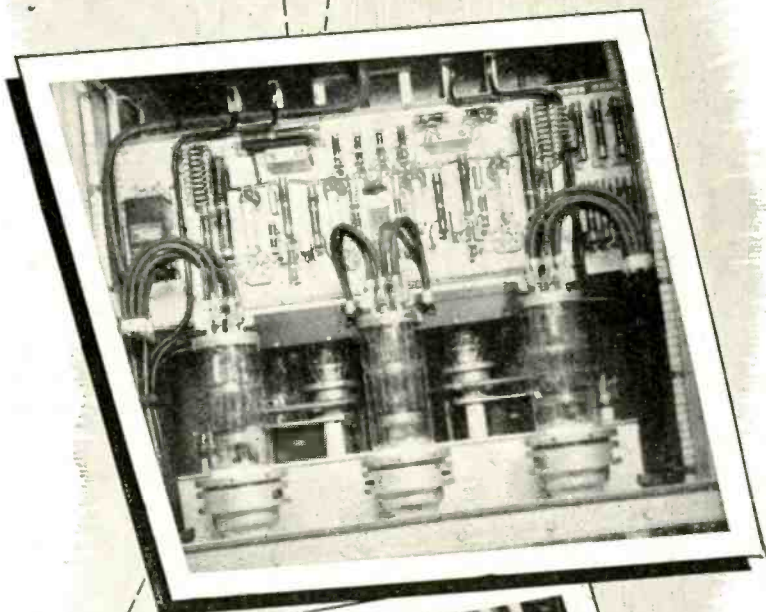

Write on company letterhead for helpful Catalog and Engineering Manual No. 40. Gives valuable data on resistors, rheostats, tap switches, chokes and attenuators.

Be Right with **OHMITE**

RHEOSTATS • RESISTORS • TAP SWITCHES

RADIO

★ SEPTEMBER, 1945

69

Lack, vice president of Western Electric.

Mr. Snodgrass' appointment follows, in less than a week, the announcement by Western Electric of their new Model 63 hearing aid which climaxes 63 years of research and development in sound transmission.

F. G. Gardner

★ Universal Microphone Co., Inglewood, Cal., has announced the appointment of a general manager, F. G. Gardner. The newly created post has been made necessary because of increased factory requirements of war production, re-conversion and postwar planning, according to statement of James L. Fouch and Cecil L. Sly, co-partners. (Photo at right)



W. S. Winfield

★ Appointment of W. S. Winfield as chief engineer of the Home Radio Division, Westinghouse Electric Corporation, was announced recently by Harold B. Donley, manager of the Division which will manufacture and market a complete line of post war radio and television receivers.

NEW PRODUCTS

[Continued from page 66]

this circuit and no current is carried by the bearings; consequently, smooth and stable adjustment of the frequency can be made over the frequency range of the instrument.

The detector is a silicon crystal so mounted that it is easily accessible for replacement. A three-stage audio amplifier is included, having an effective band width of 50 kilocycles. The output of the amplifier operates a panel meter and a built-in loud-speaker. A jack is provided for head telephones.

For complete data, write the General Radio Co., 275 Massachusetts Ave., Cambridge 39, Mass.

CAPACITOR NOMOGRAPH

A Pulse Service Capacitor Nomograph prepared in convenient form by the Engineering Department of the Sprague Electric Company, North Adams, Mass., and offered by them free of charge, will prove decidedly helpful to engineers and others involved in pulse service capacitor applications.

Although the Nomograph is primarily designed for determining the volt-amperes through a capacitor used in rectangular pulse service, it first, as an intermediate step, finds the d-c (unit pulse) energy content which, in some cases, may be sufficient. In writing for the Nomograph, ask for Sprague Technical Bulletin No. 11.

NEW CAPACITORS

Centralab Tubular Ceramic Capacitors can now be supplied in any desired temperature coefficient between +120 and -4000 parts per million per degree Centigrade.

The range from -750 to -4000 parts per million is *new* and has the same accuracy of temperature compensation curve and uniform electrical characteristics as the present standard ranges.

The new ceramic bodies have somewhat higher dielectric constants and thus provide higher values of capacitance on the same size tube. They are not to be confused, however, with the so-called Hi-K or high dielectric bodies that have still higher dielectric constants but less uniform characteristics.

NEW TRANSFORMER

A new series of hermetically-sealed aluminum case output transformer has been designed by The Acme Electric Mfg. Co. of Cuba, N. Y. According to the manufacturers, the use of annealed steel cores,

**NOW AVAILABLE!
WESTERN ELECTRIC AND OTHER
SURPLUS ELECTRONIC TUBES**

General Electronics, Inc., acting as agent of Reconstruction Finance Corporation under Contract No. SIA - 2 - 53 has been appointed exclusive sales agent for the disposal of all surplus stock Western Electric Power Vacuum Tubes as well as those of other recognized manufacturers.

The tubes listed here are in stock, ready for immediate shipment. Standard list prices prevail, with discount offered on quantity purchases. No priority is required and all tubes are available for export. Write, wire or phone.

WESTERN ELECTRIC COMPANY TUBES

3824	203A	267B
5D21	205B	268A
RM30	205F	269A
102D	212D	283A
102F	215A	285A
104D	222A	309A
125A	245A	
313A	357A	714AY
313C	394	717A
313CD	394A	723A/B
316A	705A	724A/B
343A	723	726A
345A		
350A		
353A		

SURPLUS TUBES OF OTHER MFRS.

10 Special VT25A	805
2C22 (7193)	807 (VT100A)
2C45 (38142) VT52	810
221A	811 (VT217)
371B	813
531	864 (VT24)
615 (VT235)	872A
801A (VT62)	1616
953B	1625 (VT136)
1961	1626 (VT137)

VT217A(WL534)(10075)

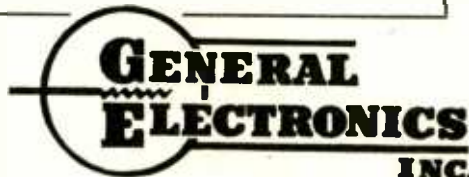

1819 Broadway, New York 23, N. Y.

Circle 7-8093

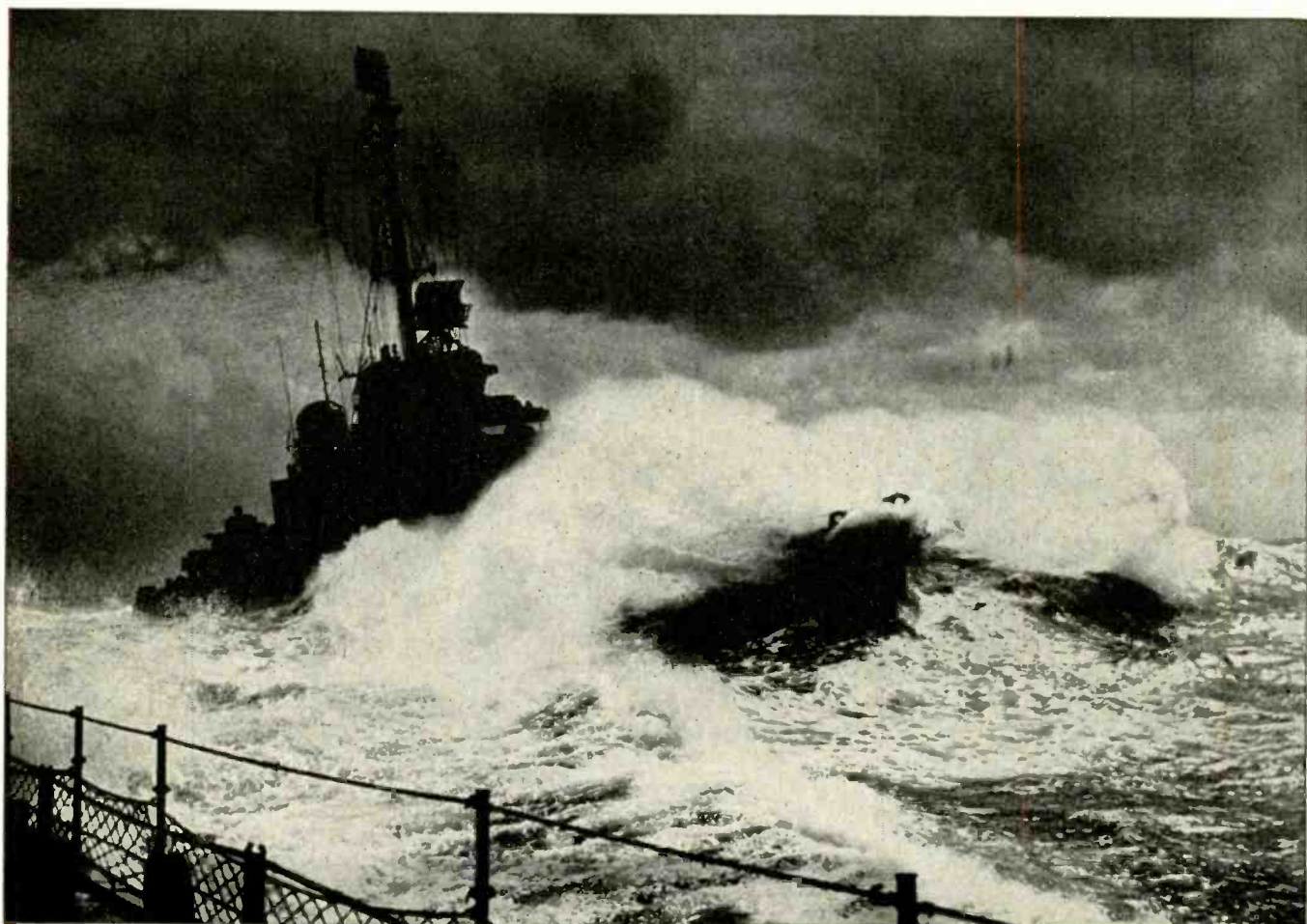

OFFICIAL U. S. NAVY PHOTO

Any port in a storm ... but there are no ports

More than one sailor has said, "It's a helluva place to fight a war!"

That's a miracle of understatement when you know the Pacific as well as the U. S. Navy knows it.

They know how many thousands of miles you have to go before you reach the fighting fronts.

They know there's almost continual rain and bad weather to hamper operations after you get there.

And they know there are no good ports!

Think of the thousands of ships, and the millions of tons of supplies it takes to keep our fighting forces moving toward Japan.

Imagine, if you can, the problem of handling those ships and supplies with no port facilities.

There are no giant cargo cranes... no miles of docks and warehouses... nothing but beaches, and human backs, and a refusal to call any job impossible.

Remember, too:

It takes 3 ships to do the supply job in the Pacific that 1 ship can do in the Atlantic.

It takes 6 to 11 tons of supplies to put a man on the Pacific battleline, and another ton per month to keep him supplied.

It takes a supply vessel, under ideal

conditions, half a year to make one round trip.

Add up those facts, multiply by the number of sailors, soldiers, and marines for whom the Navy is responsible.

Maybe you'll begin to realize what "no ports" can mean in the rough, tough waters of the Pacific.

Maybe you'll see that we have two reasons to be proud of the U. S. Navy. *First*, the way they've sunk the enemy's ships.

Second, the way they sail your ships... taking the worst the Pacific can hand them... but keeping the supply lines open... keeping the attack on schedule!

SPERRY GYROSCOPE COMPANY, INC. GREAT NECK, N. Y.



Division of the Sperry Corporation

LOS ANGELES • SAN FRANCISCO • SEATTLE • NEW ORLEANS
CLEVELAND • BROOKLYN • HONOLULU

MAKERS OF PRECISION INSTRUMENTS FOR THE ARMED FORCES

RADIO ★ SEPTEMBER, 1945

71



**Post-war
Parade**

● Hats off to these veterans! They have served with rare distinction on many battle fronts — on land, on sea and in the air. And after the needs of our fighting forces are fully met, these heavy-duty micacs, oil-filled capacitors, paper capacitors and electrolytics will once again be generally available. Because of their wartime service, they will be still better prepared to meet the heavy-duty requirements of post-war radio and electronics. ● Consult our local jobber. Or write us direct.

AEROVOX
Capacitors
INDIVIDUALLY TESTED

AEROVOX CORP., NEW BEDFORD, MASS., U. S. A.
In Canada: AEROVOX CANADA LTD., HAMILTON, ONT.
Export: 13 E. 40 St., New York 16, N. Y. Cable: 'ARLAB'

and special vacuum impregnated coils considerably improves the operating efficiency and general overall performance.

Terminals of Pyrex glass with Kovar electrodes and Kovar metal collars form a hermetical seal that comply with the standards established for 5 cycle immersion tests.

FREE BOOKLET

To all interested in permanent magnets. The Arnold Engineering Company is offering, without charge or obligation, a new treatise written by Raymond L. Sanford and published by the U. S. Department of Commerce. Entitled "Permanent Magnets" and consisting of 30 pages of permanent magnet theory, design, data and references, this book is considered by Arnold engineers to be a very informative study and of considerable value to present and prospective users of permanent magnets.

As a service to industry, Arnold is making it available to those who write for it on their company letterheads.

Requests should be addressed to The Arnold Engineering Company, 147 East Ontario Street, Chicago 11, Illinois.

MILLIOHMETER

Milliohmmeter No. 673-F is a new addition to the rapidly growing group of direct reading resistance measuring test sets produced by the Shallcross Manufacturing Co., Collingdale, Pa. This instrument has linear scales which eliminate crowding of the higher values of resistance at one end of the scale. The six scales have ranges as follows: 0-0.5-1-5-10-50 and 100 ohms full scale. This range of resistance measurements bridges the gap between the regular Shallcross Milliohmmeters that are used extensively for low resistance testing and the ordinary ohmmeters used for relatively high resistance measurements.

The instrument utilizes separate connections for current and potential so as to minimize the effect of lead and contact resistance when measuring low values. The instrument uses a single #6 dry cell battery carried in a battery compartment built into the instrument.

UHF AND TELEVISION NOMOGRAPHS

Nomograph charts never before available, providing radio engineers with an invaluable tool in the design of equipment for the UHF and television ranges, have been issued by the Federal Telephone and Radio Corporation of Newark, N. J., associate of the International Telephone and Telegraph Corporation.

The set now being offered, twenty-five in number, represents the beginning of a projected series of more than one hundred graphic aids to the designer of radio, UHF and television equipment. This series will prove an important contribution to progress in the radio art, by eliminating much of the laborious computations formerly required for the design of such equipment, and reducing them to a few simple operations with a straight edge.

For instance, six of the charts now being offered are for use in the design of double and triple tuned band-pass circuits

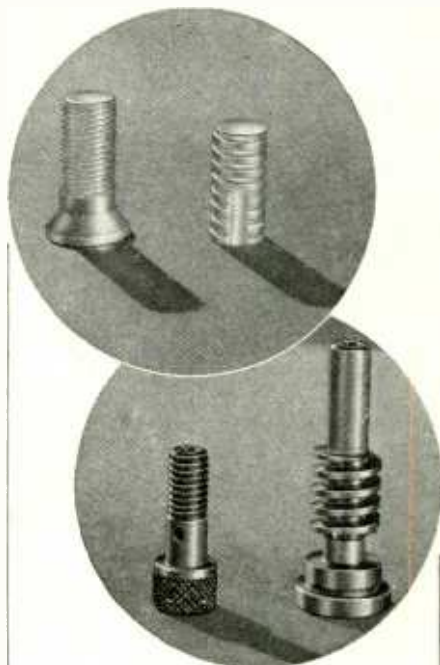

SIMILAR DESIGN DIFFERENT MATERIALS

HARTFORD offers you a proficiency you can use profitably in the competitive years ahead . . . metal or plastic component parts from Rod or Tubing . . . screw machine products by design of methods based on expert engineering knowledge . . . secondary equipment unusually diversified for precision production of complete mechanical assemblies.



PLASTICS

From Rod & Tubing



**Centerless Ground
Machined • Borizing • Slotted
Milled • Knurled • Drilled
Threaded • Tapped**

Metal Inserts



SCREW MACHINE PRODUCTS

1/64" to 5" Dia. All Metals



**THE HARTFORD MACHINE
SCREW COMPANY
HARTFORD, CONNECTICUT**

Since 1876



**"CONFIDENTLY, SMITHERS, BOSCO IS A COIL HOUND.
HE SHOWS US WHERE WE CAN GET ALL THE COILS WE NEED"**

SUPER-QUALITY COILS AT REASONABLE PRICES

More and more every day, the industry is turning to Albion for fast, quality and quantity production of coils, chokes, and transformers. That's because here you benefit from the unbeatable combination of management "know how," skilled workmanship, streamlined facilities, and central location. Your requirements will be given prompt and thoughtful attention.

ALBION

COIL COMPANY

ALBION, ILLINOIS

R. F. AND TRANSMITTING COILS AND CHOKES;
I. F. TRANSFORMERS

Who is a major supplier of critical radio and electronic equipment to industry, war agencies, service men, schools, etc.?

?

HARVEY!

Who can locate hard-to-find parts, or recommend effective substitutes, for the harassed purchasing agent?

?

HARVEY!

Who has up-to-the-minute information on latest developments in the field for present or postwar use?

?

HARVEY!

Who takes every possible means to deliver the goods promptly, to give you extra-special service without extra cost?

?

HARVEY!

HARVEY has been in the business for a dozen and a half years. We stock lines of leading radio and electronic manufacturers. And we back them up with our own specialized experiences which, in turn, can save you time, trouble and money.

Telephone Orders to LO. 3-1800

HARVEY
RADIO COMPANY
HARVEY

103 WEST 43rd ST., NEW YORK 18, N. Y.

in the UHF and television ranges, and provide a quick and easy means of answering the questions which arise in the design of such circuits.

Two of the nomographs cover Series and Shunt-Peaking Methods of Range Extension in Wide-Band Amplifiers, while other charts relate to impedance characteristics in various types of transmission lines, including single wires in troughs and in square outer conductors; balanced two-wire and concentric lines, air-spaced, and with solid dielectric; quarter wave matching sections, and sending-end impedance in uniform lines.

Particularly valuable are charts treating transmission line lengths, cut-off frequencies in circular wave-guides, UHF path lengths and optical line-of-sight distances. The remainder of the charts allow rapid calculation of deflection sensitivities of cathode-ray tubes, modulation percentages from oscillograms, reduction in gain caused by feedback, and dissipation of power in water-cooled devices.

NEW PICKUP

Production of a high fidelity magnetic phonograph pickup to sell in competition

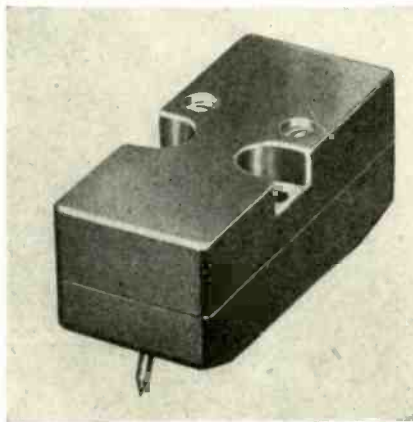

with crystal pickups is announced by the Caltron Company of Los Angeles.

Among the advantages claimed for this new pickup are a smooth response to 6,000 cps and a sharp cutoff beyond top frequency.

The unit has no bearings, pivots or needle chuck. It is stated the unit will track fully modulated pressings with 15 grams needle pressure.

It has extremely low needle talk and eliminates all problems connected with temperature and humidity. Also, with this pickup, no scratch filter is needed in the amplifier.

For further details write the Caltron Company, 11746 West Pico Boulevard, Los Angeles 34, California.

822-S TRIODE

A high-power triode with a frequency application limitation of 30 mc has been announced by Frank J. Hajek, president of Taylor Tubes, Inc., 2312 Wabansia Avenue, Chicago. Designed for peak performance in all r-f services, diathermy and Class B audio, the tube is usable in induction heating applications as well.

The Taylor 822-S, as the tube is num-

bered, will furnish up to 1 kw of audio output in Class B (in pairs) at 3000 volts and 0.5 ampere on the plates or as low as 400 watts audio in Class B with 1500 volts at 0.390 ampere. As a Class C amplifier (telephone) its maximum ratings include

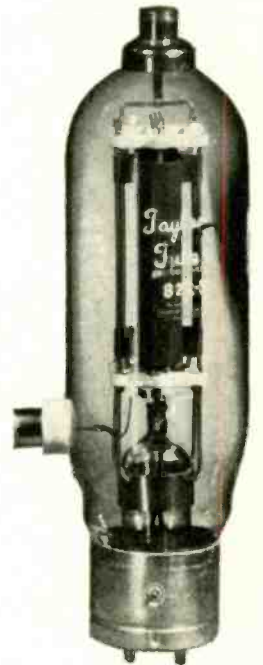

Taylor type 822-S triode, designed for operation at frequencies up to 30 megacycles

a power output of 405 watts with 2000 volts at 0.250 ampere on the plate and 13.7 watts driving power. Under typical Class C (telegraphy) ratings the tube will provide 600 watts output with 2500 volts at 0.3 ampere on the plate with a driving power of 17 watts.

Electrical characteristics: Filament—10 volts at 4 amperes; Amplification factor—30; Plate dissipation—200 watts; Interelectrode capacities—grid-plate: 13.5 μmf , grid-filament: 8.5 μmf , plate filament: 2.1 μmf ; Maximum overall length—9 in.; maximum glass diameter—2 $\frac{5}{8}$ in.; base—standard 50-watt; glass—Nonex.

Typical Ratings (Class C telegraphy): Plate d-c volts—2500, Plate d-c Current—300 ma., Grid d-c current—51 ma., grid bias d-c volts—minus 190, (from grid leak of 3730 ohms or fixed supply of 100 volts plus a grid leak of 1765 ohms), Plate dissipation—150 watts; power output—600 watts; driving power—17 watts.

LOW FREQUENCY CRYSTAL

Bliley Electric Company, Erie, Pa., announces a new low frequency crystal unit that will maintain its frequency within considerably narrower limits than were heretofore obtainable.

In this unit, the FM6, a resonant pin assembly, has been employed. The steel pins are mechanically resonant to the crystal frequency or some multiple of that frequency so that any damping effect of the clamping pins is negligible. The internal assembly is protected against moisture and humidity by means of a captive gasket seal employed between the aluminum shell and laminated phenolic case. Formerly, most crystals in the range 70 kc to 400 kc were either clamped between phenolic knife

edges or placed in a fixed air-gap assembly which allowed the crystal to shift between its electrodes with resulting shifts in crystal frequency.

The FM6 is intended for such applications as frequency standards, timers, measuring equipment, frequency meters, carrier current and other applications where an accurate source of low frequency is required.

AIRCRAFT RADIO UNIT

On National Aviation Day, Airadio, Incorporated, Stamford, Connecticut, announced final production plans for a receiver-transmitter unit weighing only ten pounds, ten ounces, for private aircraft.

The AIRADIO Two-Way communication system is compact, highly sensitive,



and ruggedly constructed. The two-band aircraft receiver, and the transmitter give the highest performance and dependability under all flight conditions. The set offers standard plane to ground communication, radio range, weather broadcast, and standard broadcast reception, as well as interphone between pilot and passengers.

A space the size of a postcard is all that is necessary on the aircraft instrument panel for mounting the receiver. The edge-lighted slide rule dial is accurately calibrated and greatly simplifies tuning. The transmitter does not have to be accessible in flight and may be installed in a remote location.

Airadio also has incorporated a radio range filter into the receiver. When listening to a weather or other voice broadcast from an airways simultaneous radio range station, the range signal can be eliminated by merely flicking a toggle switch located in the front panel of the receiver. This permits reception of voice only.

NEW G-E BFO

A new beat frequency audio oscillator, Type AO-2, has been announced by the Specialty Division of the General Electric Company's Electronics Department.

Using full vision and making possible direct calibration, the unit provides a stable sine wave, continuous variable frequency from 25 to 15,000 cycles per second. The panel control knob regulates the output level from zero to full power output.

A Type 6E5 Electron-ray Tube is used to indicate zero beat while adjusting the panel control knob to obtain the proper relationship between the two high frequency oscillators. The maximum output

Toroids..

by
DX

Doughnut Coils for electronic and telephone purposes. High Permeability Cores are hydrogen annealed and heat treated by a special process developed by DX engineers. Send us your "specs" today—ample production facilities for immediate delivery.

DX RADIO PRODUCTS CO.
GENERAL OFFICES 1200 N. CLAREMONT AVE., CHICAGO 22, ILL., U.S.A.

DX COILS
"the heart of a good receiver"

Hi-Q

CERAMIC CAPACITORS

WIRE WOUND RESISTORS

CHOKE COILS

The line to "get a line on" for your post-war sales.

ELECTRICAL REACTANCE CORPORATION
FRANKLINVILLE, N. Y.

POWER STAMINA LONG-LIFE



**SM Fractional H.P. Motors
for dependable performance**



With a SM motor, you get a unit designed for a specific job, engineered to your exact performance requirements, precision-built to your specifications, produced in volume for your needs. SM fractional H.P. motors are made to order with speeds from 3,500 to 20,000 R.P.M. — 1/10th to 1/200th H.P. — voltage from 6 to 220 AC-DC. Illustrated is the famous SM-2 Blower Motor; many thousands have been made for military purposes. Other SM motors have been designed and produced in large volume for a wide variety of radio, aircraft and other applications where rugged power, stamina, long life and dependable performance were primary requisites. What are your requirements?

Small Motors, Inc.
1308 ELSTON AVE., CHICAGO 22, ILLINOIS

DEPT. 30

Manufacturers of special small universal, fractional H.P. motors, dynamotors, shaded pole motors, heater motors, generators.

Design • Engineering • Production

of the device is 120 milliwatts on the "cathode follower" type output impedance coupling circuit.

A specifications sheet on the unit is available on request to the G-E Specialty Division, Schenectady, N. Y.

CAPACITOR REFERENCE GUIDE

A new type, twenty-four page capacitor reference manual has just been released by The Magnavox Company of Fort Wayne, Indiana.

Of particular interest to designers and engineers, it gives complete reference material for all standard sizes of Magnavox capacitors available, with cross references to standard production numbers. In addition, anode size factors, leakage limits and resistance limits are charted for quick reference.

Copies are offered free, when requested on your company letterhead.

NEW C-D CATALOG

The new catalog No. 195 just issued by Cornell-Dubilier Electric Corporation is of special interest to those engaged in servicing radios. It contains complete data on capacities, sizes and prices of Cornell-Dubilier electrolytic capacitors—can-types and cardboard tube types, paper capacitors—wax impregnated and Dykanol tubular capacitors, drawn metal shell units, replacement paper units, photo-flash units, auto radio units and transmitting paper types also various types of mica capacitors. Capacitor Test Instruments and Interference Filters also are included.

Copies of Catalog No. 195 may be had on request to Cornell-Dubilier Electric Corporation, South Plainfield, N. J. or New Bedford, Mass.

TUBES FOR FM

The allocation of FM to the 88-108 mc band raises the question as to what tubes are now available for use in receivers operating at these frequencies.

Sylvania lists below several types which operate satisfactorily in this band. The listings include such characteristics as mutual conductance, inter-electrode capacitances, and electrode currents, for quick reference.

Tubes for efficient operation in the 88-108mc band must incorporate all the latest

design features required for UHF. Lock-in tubes are therefore especially useful since they incorporate short, one-piece, straight-through widely spaced leads which are essential for low lead inductance, low inter-electrode capacitances, and low dielectric loss. The Lock-in structure permits direct circuit connections and eliminates the phenolic base with its dielectric loss.

MICA TRIMMERS

A 12-page catalog which contains a foreword stating the case for the use of standard parts in post-war radios and similar electronic equipment requiring Mica Compression Trimmers, has been issued by the Automatic Manufacturing Corporation, 900 Passaic Avenue, East Newark, New Jersey. In it are listed and clearly illustrated all the standard type trimmers.

Complete specifications are given for each type, including capacity curves and outline drawings showing every essential dimension.

HYPASS NON-RESONANT CAPACITORS

Recently developed by the Sprague Electric Company, North Adams, Massachusetts, Sprague Hypass capacitors are unique in that they do not show resonance at frequencies as high as 50 megacycles and, in many instances, even up to 300 megacycles. As a result, the units are of great advantage in the filtering or bypassing over wide frequency bands where previous capacitors were generally unsatisfactory. Earlier methods of bypassing generally called for use of a paper capacitor shunted by a mica capacitor, or the use of different values of capacity for different bands. Hypass capacitors are installed by connecting them in the circuit in the same manner as a low-pass filter would be connected. Their two terminals are connected in series with the circuit, and the container is grounded in the usual manner. They may be used to eliminate "hash" in many circuits replacing relatively complicated and bulky filters.

Details on Sprague Hypass capacitors will gladly be sent on request to the manufacturer.

RF OR IF AMPLIFIERS

Type	E_r Volts	I_r ma.	G_m μ hos	C_{g-p} μ f.		C_{input} μ f.	C_{output} μ f.	I_b ma.	I_{c2} ma.
7A7	6.3	300	2000	0.005	max.	6.0	7.0	9.2	2.6
7B7	6.3	150	1750	0.007	"	5.0	6.0	8.5	1.7
7C7	6.3	150	1300	0.007	"	5.5	6.5	2.0	0.5
7H7	6.3	300	4200	0.007	"	8.0	7.0	10.0	3.2
7L7	6.3	300	3100	0.01	"	8.0	6.0	4.5	1.5
7W7	6.3	450	5800	0.0025	"	9.5	7.0	10.0	3.9
1204	6.3	150	1200	0.05	"	3.2	4.0	1.75	0.6

CONVERTERS

Type	E_r Volts	I_r ma.	G_c μ hos	G_m	Oscillator μ hos	Total I_k ma.
7S7	6.3	300	525		1650	10.2

OSCILLATORS

Type	E_r Volts	I_r ma.	G_m μ hos	C_{g-p} μ f.	C_{input} μ f.	C_{output} μ f.	I_b ma.
7A4	6.3	300	2600	4.0	3.4	3.0	9.0
7E5/1201	6.3	150	3000	1.5	3.6	2.8	5.5
7F8	6.3	300	5200*	1.2*	2.8*	1.4*	10.5*

*Per Section.

TROPICALIZED KOOLOHMS

A new catalog featuring Sprague Koolohm Resistors for all radio and general service uses has just been issued by the Sprague Products Company, North Adams, Mass.

All resistors listed are the new Koolohm types having the "Tropicalized" glazed outer protective shell and new type moisture-proof end seals which make them applicable for use under any climatic conditions. All Sprague Koolohm Resistors now have this exclusive construction, following extensive tests in both Sprague laboratories and by the armed forces.

A copy of the new catalog which gives details on 5, 10, 25, 50 and 120 watt fixed as well as 10 watt adjustable types will gladly be sent on request.

NEW AIR TRIMMER

Comar Electric Company, Chicago manufacturers of electrical control devices and other equipment announce their new Air Trimmer Condenser.

According to the manufacturer the new Air Trimmers are available either single or dual, and have a ceramic mounting base, with brass plates and mounting studs, cadmium, silver or nickel plated as required. Capacities range from 5 to 140 mmf with the following standard air gaps, .012, .015, .019, .030, .045.

Complete details and prices may be obtained from Comar Electric Company, 2701 Belmont Ave., Chicago 18, Illinois.

G-E PORTABLE OSCILLOSCOPE

A new portable oscilloscope, Type CRO-3A, has been announced by the Specialty Division of the General Electric Electronics Department.

This unit is equipped with a 906-P1 cathode-ray tube which has a greenish screen that can be viewed in daylight. A unique special design removes the a-c ripple from the a-c transformer field and gives a sharper and more clearly defined signal picture. Moderately high-speed traces can also be photographed on this screen.

The unit has a wide range sweep circuit featuring a linear amplifier. Sweep rates from 10 to 30,000 per second, adjustable by a 7-point vernier switch.

A specifications sheet on the unit is available on request to the G-E Specialty Division, Schenectady, N. Y.

TEST EQUIPMENT

The inherent accuracy and reliability of accepted laboratory circuits and techniques reduced to simplest terms for lay operation in everyday industry, characterizes the variety of instruments featured in the "Electrical Test Instruments" bulletin released by Industrial Instruments, Inc., 17 Pollock Ave., Jersey City, N. J.

Among the instruments featured are the direct-indicating comparison bridge, capacity and resistance limit bridges, resistance and capacitance decades, Wheatstone bridge, voltage breakdown testers and test fixtures, Kelvin bridge, megohm bridge and megohm meter, and conductivity apparatus. Copy may be had on request to manufacturer.

ATTENUATORS

by

TECH LABS



STANDARD
TYPE
700



MIDGET
TYPE
600

"Midget" model is especially designed for crowded apparatus or portable equipment.

- Solid silver contacts and stainless silver alloy wiper arms.
- Rotor hub pinned to shaft prevents unauthorized tampering and keeps wiper arms in perfect adjustment.
- Can be furnished in any practical impedance and db. loss per step upon request.
- TECH LABS can furnish a unit for every purpose.
- Write for bulletin No. 431.



Manufacturers of Precision Electrical Resistance Instruments
337 CENTRAL AVE. • JERSEY CITY 7, N. J.

Look Here...



for Radio Parts
for specialized equipment





for Industrial and Professional Use
Transformers and other Audio Components.

Resistors, condensers and thousands of other hard-to-get
parts immediately available on priorities.



Phone, wire or write us your requirements.
Selections made and shipped same day your order is received.

RADIO WIRE TELEVISION INC.

World's Largest Radio Supply House • Known since 1922 as reliable jobbers, wholesalers and manufacturers of radio and electronic equipment

100 SIXTH AVENUE, Dept. Q-9, NEW YORK 13
BOSTON, MASS. • NEWARK, NEW JERSEY

ORIGINATORS AND PEACETIME MARKETERS OF THE CELEBRATED

Lafayette Radio

LOUD SPEAKER ENGINEER

Large Eastern component parts manufacturer needs graduate engineer with several years design and development experience on loud speakers. Should be capable of handling developments through complete engineering design. Excellent post-war opportunity. Salary open. State full particulars, age, education and experience.

Box No. 725

% Radio Magazines, Inc.

342 Madison Ave.
New York 17, N. Y.

TECHNICANA

[Continued from page 32]

there is no restriction as to direction of movement.

For example, it is desired to heat 500 grams of a material through 110°C rise in two minutes. The material has the following values: $S = 0.3$; $K = 4.0$; $\cos \varphi = 0.05$; and $\varphi = 1.0$. Also $f = 15$ mc. Starting in quadrant A at $\theta_0 = 110^\circ\text{C}$, we get $W_p = 0.038$ watt-hours for $S = 0.3$. In quadrant B , for $t = 2$, $P_p = 1.15$ watts/gm. In quadrant C , for

$$K \cos \varphi = 0.2, E/d = 1000 \text{ volts/cm}$$

for 10 mc, and 720 volts per cm for 15 mc, from quadrant D .

Mr. Maddock also tabulates the physical constants, referred to, for several types of plastics and wood. It is noted in this connection that the temperatures to which the materials are to be heated will depend upon the material and the heating operation to be performed. Additionally, the values of K and φ must be determined at the operating frequency employed.

The author also illustrates graphically that since standing waves may be found on an electrode of length comparable to the wave length employed, there are certain maximal lengths of load which may be used at various frequencies and for various values of K .

Longitudinal Heating

Longitudinal heating for laminated plywood is preferred to transverse heating when the dielectric constant of the glue exceeds that of the wood. This is usually the case for most types of synthetic resin glues, so that the electric field should be applied along the line of the glue.

The above is the conclusion of Mr. D. I. Lawson in an article entitled "Longitudinal or Transverse Heating". Formulae are derived for both cases.

Eddy current heating, as distinguished from dielectric heating, is utilized in the production soldering of tin-plate containers. Mr. Christopher E. Tibbs, of Rediffusion Ltd., in an article entitled "Radio Heating and Mass Production Soldering" describes some of the problems involved.

Mr. Christopher's assembly line performed some 1200 soldering operations per hour. Capacitor cans were soldered to their tops. It was found that too rapid heating caused the end caps to distort due to unequal distribution of temperatures in the can. When the containers were heated more slowly, on a moving conveyor, several cans were in the field of the induction coil at one time, and the production rate was maintained. It was also found necessary to adjust the

SELL THE
Rapidly Growing

INDIA MARKET!

An old established sales agency with sales and warehousing facilities in principal trading centers throughout India, seeks connections with leading American manufacturers.

Widely experienced in the sale of radio and allied equipment, we can additionally represent manufacturers of speakers, amplifiers, antennae, microphones, transformers, receivers, transmitters, etc.

We will furnish first class banking references. All transactions on letter of credit basis.

United Agencies, Ltd.,
Bombay, India.

Address inquiries to our American representatives.

WM. RICHMAN SUPPLY CORP.

50 Beaver St.

New York, N. Y.



FREE TO YOU

COLOR CODE and OHMS LAW CALCULATOR

Great Time Saver

Burstein-Applebee of Kansas City offers you this great convenience FREE. Easy to work. Solves many problems in a jiffy. FREE to Radio men, electronic engineers and others in the business. Attach coupon to your letterhead.

MAIL COUPON NOW

BURSTEIN-APPLEBEE CO.
1012 MCGEE ST.
KANSAS CITY 6, MO.

Send me FREE Color Code and Ohms Law Calculator along with latest catalog.

I am _____
STATE CONNECTION IN INDUSTRY

NAME _____

ADDRESS _____

TOWN _____ STATE _____

LOUD SPEAKER LABORATORY ASSISTANT

Eastern manufacturer, many years in business, with fine post-war picture can use young engineer, preferably with some speaker experience, to assist in design and development work. Fine opportunity. Salary open. State age, education and experience.

Give Box No. 726

% Radio Magazines, Inc.

342 Madison Ave.
New York 17, N. Y.

shape of the heating coil so that some parts of the cans did not overheat and discolor while other parts remained cooler. The author used 3 kw of power at 9 mc. The heating coil was a $\frac{1}{4}$ " dia. water-cooled copper coil some 20" long and $3\frac{1}{4}$ " wide. At the delivery end of the conveyor belt the coil was somewhat wider so that the temperature was sufficient to permit even solder flow. At the front end the field was stronger, and in this area the solder melted.

INVENTIONS

[Continued from page 60]

flows through the tube, some electrons are captured by the grid and these, because of the large grid resistor, ultimately cause the grid to reach such a high negative potential that conduction through the tube stops. This quenches the oscillation and only after the grid-leak has had time to discharge the grid

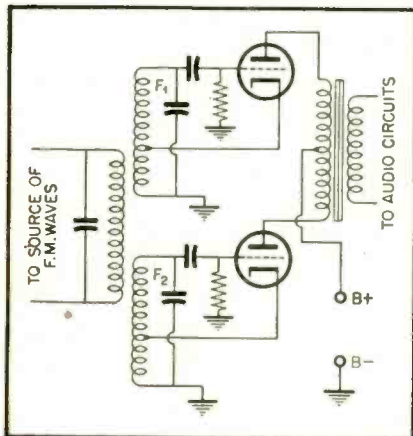

Patent No. 2,373,616

condenser, does the oscillation start to build up again. If the desired FM signal has a frequency midway between F_1 and F_2 , which are themselves sufficiently well separated to be beyond the frequency excursions of the input signal, then instantaneously one or the other of the oscillators is aided in its build-up so that it passes more current than the other tube and gives an output audio voltage that corresponds to the frequency modulation. The tank circuits F_1 and F_2 are respectively tuned to frequencies of 30 kc or higher are used. The patent is assigned to RCA and is number 2,273,616.

PRECISION RESISTORS

[Continued from page 52]

hottest point of the resistor, must also be considered in defining the high temperature properties of the unit. Conventional phenolics are satisfactory at temperatures slightly over the boiling point of water, melamines have been satisfactory to 160°C., ceramics to tem-

Specialists in Special Crystals

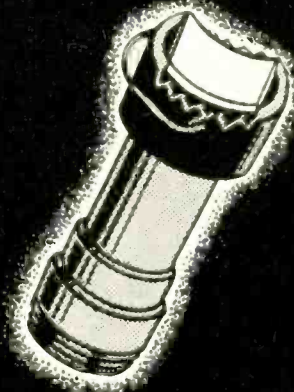

"Searching Unit" for Sperry Products' Reflectoscope



Yankee Ingenuity
makes us

SPECIALISTS IN SPECIAL CRYSTALS

SUPERSONIC CRYSTALS

Curved . . . spherical . . . or flat supersonic crystals for a full range of biological, chemical and materials testing purposes. Crystalab is specialist in them all. That's why leading manufacturers like Sperry Products, Inc., whose renowned Reflectoscope employs our supersonic crystals — come to us with their problems.

If you have a problem or product involving the use of supersonic crystals, our engineers will be glad to have you consult them.

Write Dept. R.I. for comprehensive catalogue "Selectronic Crystals" and facilities booklet "Crystalab Solves a Problem"



CRYSTAL RESEARCH LABORATORIES

INCORPORATED

LABORATORIES AND MAIN OFFICE: 79 ALLYN STREET, HARTFORD 3, CONN.

New York Office: 15 E. 28th Street, New York 10, N. Y. Phone: M.H. 5-2352

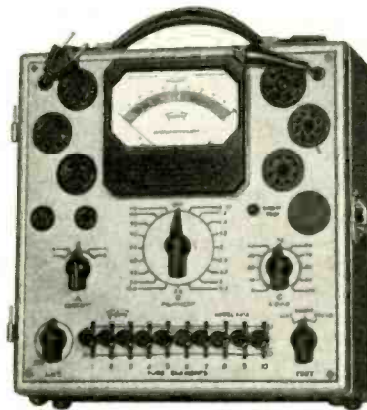

Model 2413

is another member of
the NEW TRIPLETT
Square Line

Triplet

ELECTRICAL INSTRUMENT CO. BLUFFTON, OHIO

The New Speed-Chek Tube Tester

MORE FLEXIBLE • FAR FASTER
MORE ACCURATE

Three-position lever switching makes this sensational new model one of the most flexible and speediest of all tube testers. Its multi-purpose test circuit provides for standardized VALUE test; SHORT AND OPEN element test and TRANSDUCTANCE comparison test. Large 4" square RED•DOT lifetime guaranteed meter.

Fast simple operation gives control of each tube element.
New SQUARE LINE series metal case 10" x 10" x 5 1/2", striking two-tone hammered baked-on enamel finish. Detachable cover. Tube chart 8" x 9". Simple settings marked in large type.

Additional Features

- Authoritative tests for tube value; shorts, open elements, and transconductance (mutual conductance) comparison for matching tubes.
- Flexible lever-switching gives individual control for each tube element; provides for roaming elements, dual cathode structures, multi-purpose tubes, etc.
- Line voltage adjustment control.
- Filament Voltages, 0.75 to 110 volts, through 19 steps.
- Sockets: One only each kind required socket plus one spare.
- Distinctive appearance makes impressive counter tester.

TRANSFORMERS FOR *POSTWAR* ELECTRONIC APPLICATIONS



● Designed to meet your specifications, mechanically and electronically



Open type, plastic impregnated transformers provide adequate weatherproofing for certain applications.



This special Radio Power transformer consists of primary winding, high voltage secondary winding and filament winding.

THE ACME ELECTRIC & MFG. CO.
CUBA, N. Y.

Acme  **Electric**
TRANSFORMERS

peratures in excess of 400°C. It must be pointed out, however, that the bobbin is not the hottest point on the resistor surface and so must not necessarily withstand the hottest temperature to be attained. At the same time, the thermal conductivity of the bobbin further defines the resistor's dissipating ability.

Additional substance which defines the resistor's high temperature performance is the coating or enclosing material. It has already been pointed out that the enclosed resistor will ordinarily dissipate less energy for a given physical size than a coated resistor, since there can be no external cooling except through the enclosing medium. However, most of the enclosing substances can be operated at higher temperatures than most of the coating substances. Those enclosing materials which show good heat properties are the previously-referred-to glass and ceramic forms. Phenolics, as an outer jacket material, do not possess as good thermal properties either from the point of distortion or conductivity.

Among the coating materials, the outstanding high temperature material is the recently-introduced silicone resins. Alkyd and phenolic resins have lower temperatures of distortion than the silicones. Waxes should not be used where high temperatures are a factor.

Aging, Mechanical Failures

Incidental to resistor failures are the aging and mechanical properties of the resistor.

Aging is defined as that property of the resistor which causes a change in resistance with time. It results from some of the stresses set up in the winding operation and in the handling of the resistor during the manufacturing operation.

Aging can be accelerated on the part of the manufacturer or can be a continuous change of resistance under operating conditions. Certain baking schedules during the coating procedure can sufficiently pre-age the resistor so that it won't drift under operating conditions. Precision types should be aged for longer than the baking period if permanence of the resistance tolerance is to be observed. Some aging schedules are as much as 24 hours at 105°C.

Mechanical failures represent obvious causes of resistor failures: security of the terminals, strength of the bobbin, too fine a resistance wire, too much tension in the winding operation, supporting members abrading the resistance wire's insulation, etc.

Testing

A certain amount of testing is necessary, even after the resistor has been chosen of the proper materials. These tests will be described briefly since the



**EASILY, QUICKLY
IDENTIFIED!**

Unlimited coding plus maximum insulation resistance

Spiralon, a new Surco plastic insulated wire, spiral striped, offers the widest range of tracer code identification in small as well as large sizes of wire, in short as well as long lengths. By avoiding use of color pigments, the primary covering retains full insulation resistance.

With Nylon Jacket

Spiralon reduces weight, permits a smaller OD., increases fungi and abrasion resistance, allows increased voltage, improves all electrical properties, eliminates all voids in the covering which ordinarily weaken such properties, resists creepage when terminals are being soldered or injury to wire insulation when accidentally touched by a hot soldering iron in production and overcomes deterioration from age. This high heat, low temperature non inflammable nylon jacket has already proved to be ideal for many applications.

A complete presentation on Spiralon is on the press. Please ask for your copy.

Address Dept. J

Surprenant
ELECTRICAL INSULATION CO.
84 Purchase St., Boston 10, Mass.

There are two funny things
about Wilmer



The first is Wilmer's getup.

The second is that he doesn't care if he does look like a castoff scarecrow.

Because Wilmer's a lot smarter than he looks. While he's making more than he's ever made before—he's doing right by his country. The dough he'd spend for a fancy wardrobe goes right smack into War Bonds . . . and for this Uncle Sam is mighty proud of him.

And Wilmer's doing right by *himself*, too. Because in a few short years he's going to be able to do something he's planned on. He's going to send Wilmer, Jr. to college—and in clothes that won't be any fugitives from a scarecrow, either.

He's going to be able to do it because Uncle Sam is going to give him back

a rich hundred bucks for every seventy-five Wilmer's *lending* now.

Naturally, you don't have to look like Wilmer . . . or tramp around in rags . . . to make your country proud of you, and your own future a whole lot more secure.

All you have to do is keep getting those War Bonds—and then forgetting them till they come due. Not bad—that four dollars for every three, and the safest investment in the world!

Why not get an *extra* War Bond today?

**BUY ALL THE BONDS YOU CAN
KEEP ALL THE BONDS YOU BUY**

R A D I O

This is an official U. S. Treasury advertisement—prepared under auspices of Treasury Department and War Advertising Council

RADIO

GROUP SUBSCRIBERS SAVE UP TO 50%*

and Here's Why:



LOOK WHAT I SAVE--
A \$3 SUBSCRIPTION
FOR ONLY HALF!!!



MEBBE THEY'LL LEAVE
MY RADIO MAG FOR
ME FROM NOW ON



I NEVER GOT AROUND
TO SUBSCRIBING--THIS
IS QUICK AND EASY

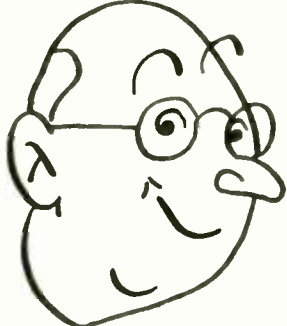

ME-I'M BUILDING A
REFERENCE LIBRARY
OUT OF EACH ISSUE

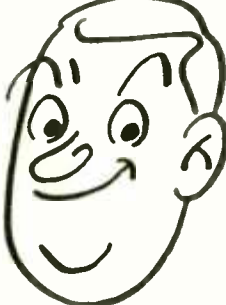

I'LL BE ABLE TO FOLLOW
PRESENT AND POST-WAR
DEVELOPMENTS



IF THEY'RE ALL GETTING
IT - I WANT TO KNOW
WHAT THEY'LL KNOW

FORM YOUR GROUP TODAY--

Every month, RADIO'S exclusive articles acquaint you with newest developments — editorial "ear-to-the-ground" releases keep you abreast of trends, in fact, ahead of most coming events.

Everyone who joins a RADIO Group saves up to half the regular cost of a RADIO subscription. The more in a Group the more each saves, up to 50%*. Present subscribers may join a Group too. We'll extend their subscription from its expiration date.

*** THE GROUP PLAN**

Here's what Group Subscriptions cost:

One 1 yr. subscription\$3.00
Two 1 yr. subscriptions 2.50 each
Three 1 yr. subscriptions	... 2.00 "
Four 1 yr. subscriptions 1.75 "
Five 1 yr. subscriptions 1.60 "
Six or more 1 yr. subscriptions	1.50 "

Make a list giving each subscriber's name, address, employer's name and their respective positions.

RADIO MAGAZINES, INC.

342 MADISON AVENUE

NEW YORK 17, N. Y.

choice of test method is up to the set manufacturer and designer.

Humidity testing can be accomplished by either a "dunking" cycle (if hermetical sealing is required) or by an air thermal shock followed by humidity exposure (if humidity life is desired). Power dissipation can be determined by intermittent load life for 1000 hours at an elevated temperature. Aging can be determined by accelerated temperature cycling.

It is heartily suggested that the resistor's construction and basic materials be considered carefully and that testing should be pursued to further determine the resistor's performance expectancy.

However, it is increasingly clear that excellent precision resistors can be obtained for radio and electronic equipments. Gone are the days when a 20% failure of precision resistors had to be expected.

SMALL RECEIVERS

[Continued from page 40]

facturer's protection. Other labels or tags are included where it is desired to instruct the customer in how to obtain the best operation from the unit. Labels and tags should be placed in such a position that they are easily read and are not damaged or made illegible with normal usage.

Instruction sheets should be concise and to the point. Long descriptions are boring to most customers and therefore are seldom read. Appearance is also a factor; if the instruction sheet is attractively printed it will stand a much better chance of receiving attention than if it is merely a plain, poorly arranged sheet of rules. Small details such as these build customer confidence, and are as much a part of the design as sensitivity or fidelity.

References:

- ¹ Choosing Tube Types—RADIO—May, June & July 1944.
- ² Army-Navy Preferred Tubes, Revised list—RADIO—Oct 1944.
- ³ Receiver Measurements—RADIO—Nov., Dec. 1944 & March 1945.

Ted McElroy

World's Largest Manufacturer of
Wireless Telegraphic Apparatus

COMPLETE CENTRAL OFFICE EQUIPMENT

McElroy Manufacturing Corp.

82 Brookline Avenue • Boston, Massachusetts

REPAIR MEN WANTED

Veterans W. W. 2 preferred with some knowledge of Radio, Motors or Electro-Medical Equipment, to learn how to service such Apparatus. Oldest est. mfr. Jobs will lead to important sales or service positions in Chicago or other cities. Good starting pay. Thorough instruction.

McINTOSH ELECTRICAL CORPORATION
223-233 N. California Avenue
Chicago 13, Illinois

ADVERTISING INDEX

ADVERTISER	PRODUCT	PAGE
Acme Elec. & Mfg. Co.	Transformers	80
Aerovox Corporation	Capacitors	72
Albion Coil Company	Coils	73
Allied Radio Company	Electronic Equipment	20
Altec-Lansing Corporation	Loudspeakers	18
American Phenolic Corporation ...	Plugs, Cables, Connectors, Sockets	9
Amperite Co.	Relays	30
Andrew Co.	Cables	24
Arnold Engineering Co.	Engineering Equipment	22
Bell Telephone Labs.	Institutional	8
Bliley Electric Co.	Quartz Crystals	19
Burstein-Applebee Co.	Electronic Equipment	78
Capitol Radio Engineering Inst. ...	Educational	26
Concord Radio Corporation	Electronic Equipment	29
Crystal Research Labs., Inc.	Supersonic Crystals	79
Drake Mfg. Co.	Dial Light Assemblies	30
D-X Radio Products Co.	Coils	75
Eitel-McCullough, Inc.	Tubes	16
Electrical Reactance Corp.	Capacitors, Resistors, Coils	75
Electronic Mechanics, Inc.	Insulation Materials	1
Esquire, Inc.	Publications	17
Federal Tel. & Radio Corp.	Cable, Wire	12, 25
Formica Insulation Co., The	Laminated Plastics	2
General Electronics, Inc.	Tubes	70
Goodrich Co., The B. F.	Insulation Material	84
Guardian Electric Co.	Relays	33
Hartford Screw Machine Co.	Screw Machine Products	72
Hallicrafters Co., The	Communications Equipment	13, Cover 2
Harvey Radio Co.	Radio & Electronic Equip.	74
Harvey Radio Labs., The	Electronic Instruments	Cover 3
Heintz & Kaufman Ltd.	Transmitting Tubes	15
Hytron Resistance Co.	Tubes	28
International Resistance Co.	Resistors	7
Jefferson Electric Co.	Transformers	11
Jensen Radio Mfg. Co.	Acoustic Equipment	21
Kaar Engineering Co.	FM Apparatus	67
Lavoie Laboratories	UHF Equipment	5
McElroy Mfg. Co.	Wireless Tel. Apparatus	83
McIntosh Electrical Corp.	Help Wanted	83
Mycalex Corp. of America	Insulating Materials	34
National Union Radio Corp.	Electronic Tubes	27
Ohmite Mfg. Co.	Rheostats, Resistors, Tap Switches	69
Racon Electric Co.	Speakers	6
Radiart Corporation	Aerials, Vibrators	23
Radio Wire Television	Electronic Equipment	77
Raytheon Manufacturing Corp.	Tubes	Cover 4
Richman, Wm., Supply Corp.	Export Sales	78
Russell Electric Co.	Record Changers, Motors, Drives	14, 31
Small Motors, Inc.	Fractional H.P. Motors	76
Sperry Gyroscope Co., Inc.	Precision Instruments	71
Sprague Electric Co.	Resistors	63
Sterling Silica Gel Co.	Dehydrant	65
Surprenant Elec'l Insulation Co. ...	Plastic Insulated Wire	80
Sylvania Electric Products Co.	Tubes	10
Tech Laboratories	Attenuators	77
Triplett Elec. Instru. Co.	Portable Instruments	79
U. S. Treasury Dept.	Victory Bonds	81
Wholesale Radio Laboratories	Electronic Equipment	32
Wrigley Jr., Co., Wm.	Institutional	68

Believe it or not ... **HE'S WAITING
FOR AN EARTHQUAKE**

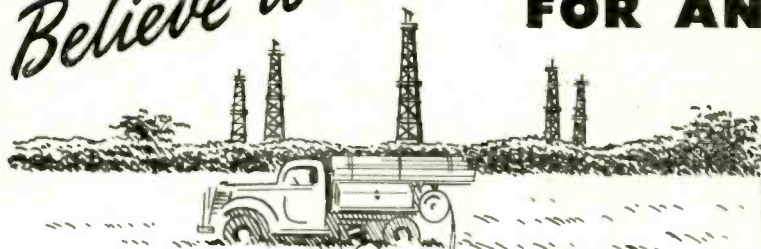

Illustrations courtesy National Geophysical Co., Inc.

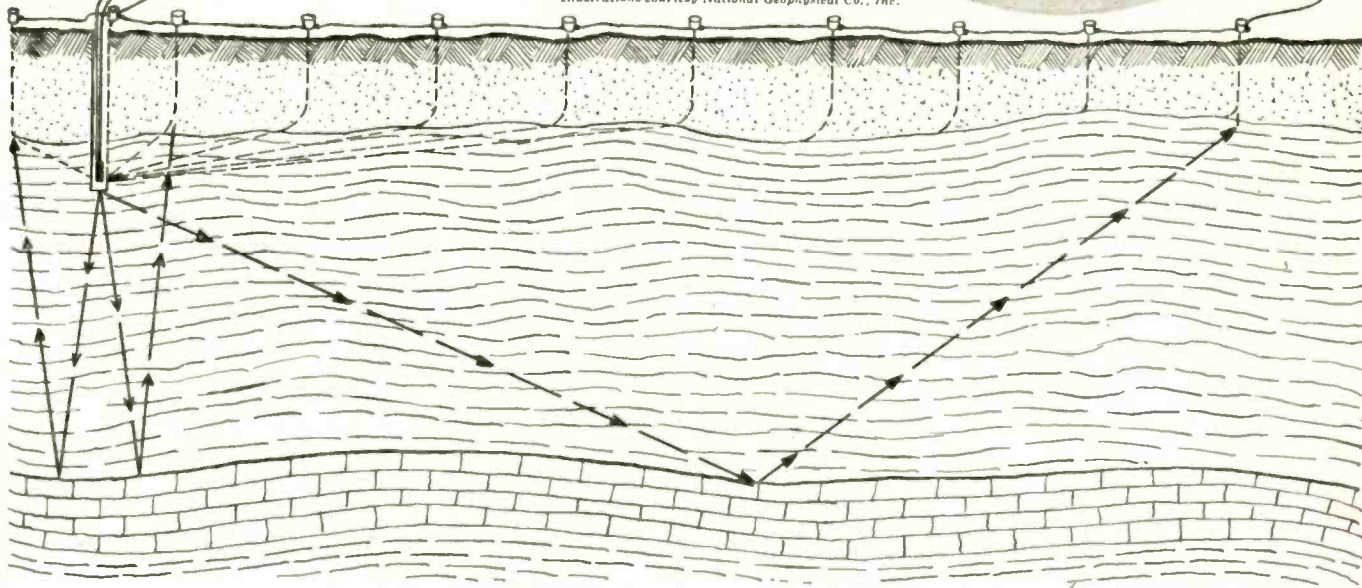

One of the best ways to locate a new oil pool is with artificial earthquakes, set up by dynamite charges and recorded on a portable seismograph carried in a truck like the one in the picture. The vibrations, after bouncing off an underground rock formation, return to the surface where they are changed into electrical impulses that are carried *through wire* to the recorder.

Any break in the wire insulation or any electrical loss caused by poor insulation would result in undependable readings—wasted time, wasted money. That's why Belden's H-8733 wire insulated with one of the GEON polyvinyl materials, is used in this service. Insulation made from GEON has, to start with, superior electrical properties. But in addition it is tough—more than tough enough to stand the rough treatment it

gets in being dragged all over the country in search of oil. Thinner coatings of insulation, made possible by GEON, mean smaller outside diameters, lighter weight. And insulation made from GEON resists nearly all the normally destructive factors—air, sun, heat, cold, chemicals, water, flame, and others. It may be colored in the entire NEMA range.

Not only in the oil fields—in domestic and industrial construction, in public utilities, in communications, in manufacturing, insulation made from GEON provides the many advantages listed above. The next time you buy wire, specify insulation of GEON.

For more information please write Department WW-9, B. F. Goodrich Chemical Company, Rose Building, Cleveland 15, Ohio.



B. F. Goodrich Chemical Company

A DIVISION OF
THE B. F. GOODRICH COMPANY



Picture These
**HARVEY REGULATED
 POWER SUPPLIES**
 In Your Laboratories



HAR-CAM

HARVEY OF CAMBRIDGE

**The HARVEY Regulated
 Power Supply 106-PA**

meets every need for a controllable, dependable source of laboratory D.C. power between 200-300 volts. Operates from 115 volts A.C...output remains constant even though line voltage varies between 95 and 130 volts. Ripple content is better than 10MV...two separate filament voltages available...6.3 volts, 5 amps each...parallel operation possible making 6.3 volts at 10 amps. available. D.C. voltmeter for measuring output. A model of efficiency and convenience.

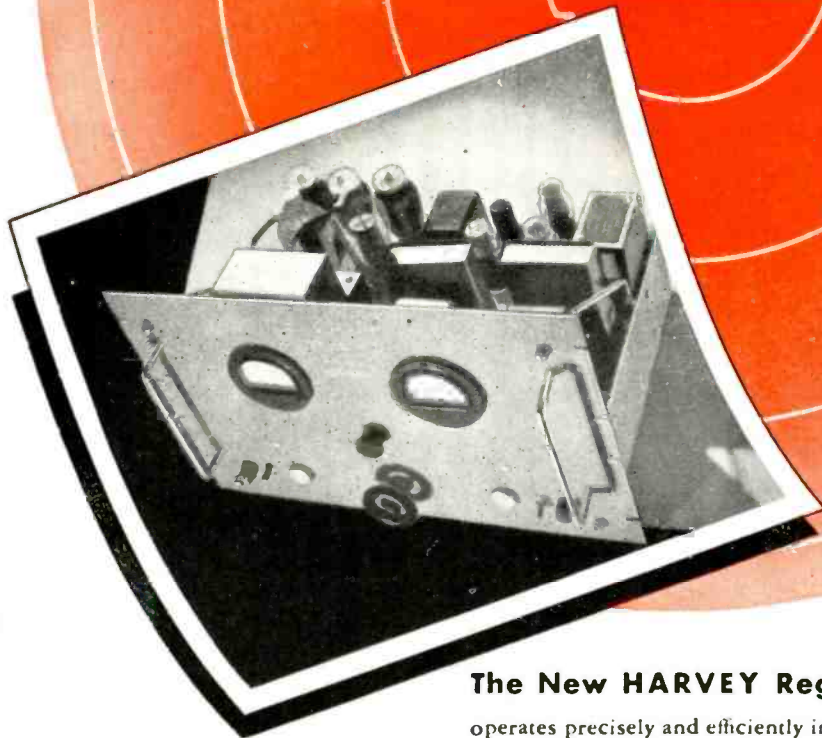

The New HARVEY Regulated Power Supply 206-PA

operates precisely and efficiently in the 500 to 1000 volt range. It provides a regulated flow of D.C. power in two ranges: 500 to 700 at $\frac{1}{4}$ amp; 700 to 1000 at $\frac{1}{5}$ amp. Ripple content $\frac{1}{10}$ of 1% or better in any voltage... 300 MV at 1000 volts or better. Output is constant within 1% from no load to full load in each range; regulation 1% or better. The HARVEY 206-PA has many safety and operating features that make it as easy and convenient to use as the 106-PA.

If your equipment includes Pulse Generators, Constant Frequency Oscillators, Amplifiers, Measurement Equipment or other apparatus requiring a constant source of D.C. Power, you should look into these HARVEY Regulated Power Supplies. We'd be pleased to send the latest bulletins on either or both. No obligation, of course.

HARVEY RADIO LABORATORIES, INC.

454 CONCORD AVENUE • CAMBRIDGE 38, MASSACHUSETTS





Peak Performance

Raytheon High-Fidelity Tubes are the *serviceman's* tubes . . . performance-engineered and precision-built to provide complete satisfaction for your customers.

To protect your interests, they are distributed only by legitimate wholesale radio parts distributors in your area.

Switch to Raytheon Tubes *now* . . . and be on the lookout for a revolutionary merchandising program developed by Raytheon to help qualifying service-dealers increase their profits through building public trust and confidence.

Copyright 1945

Raytheon Manufacturing Company

RADIO RECEIVING TUBE DIVISION

NEWTON, MASS. • LOS ANGELES • NEW YORK • CHICAGO • ATLANTA



Listen to
"MEET YOUR NAVY"
AMERICAN
BROADCASTING CO.
Every Monday Night
Coast to Coast
181 Stations



ALL FOUR DIVISIONS HAVE BEEN
AWARDED ARMY-NAVY 'E' WITH STARS

DEVOTED TO RESEARCH AND THE MANUFACTURE OF TUBES FOR THE NEW ERA OF ELECTRONICS